

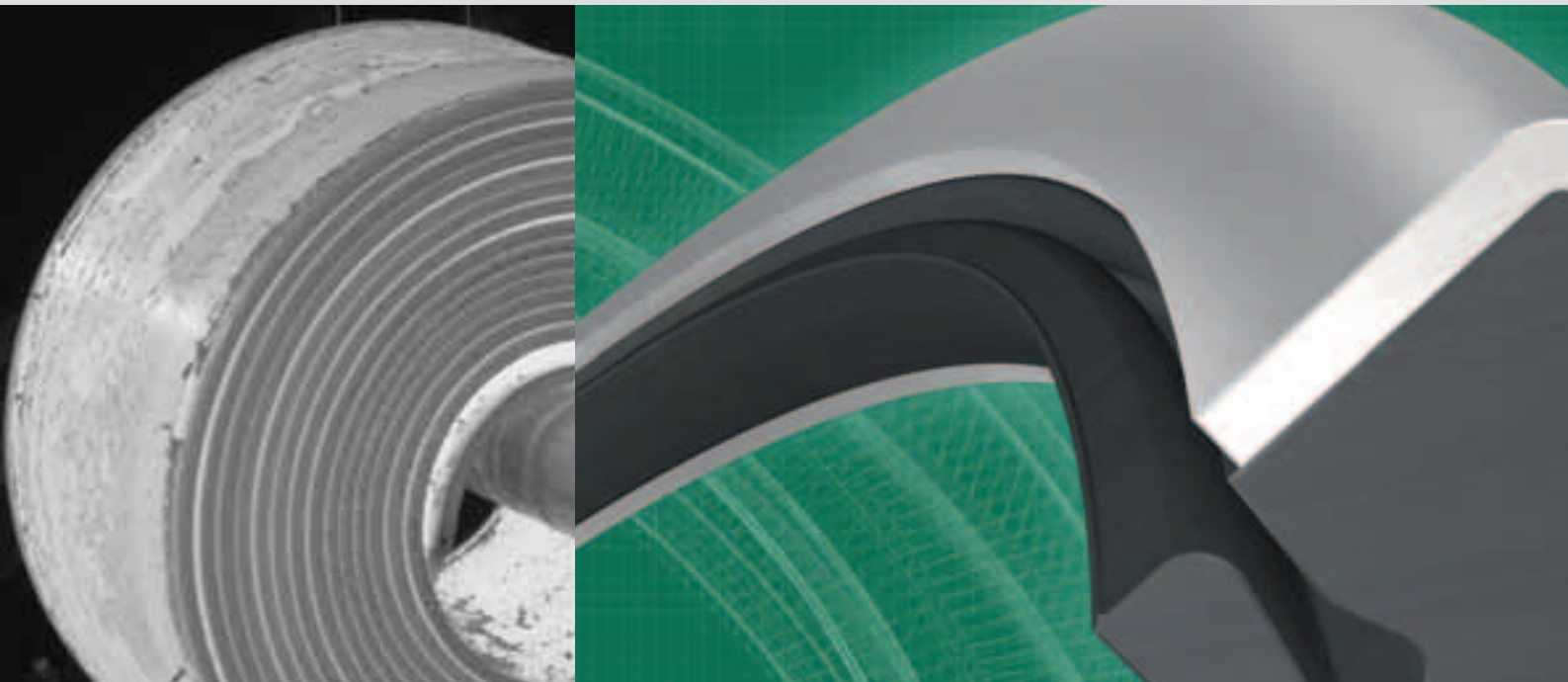

CR LARGE DIAMETER SEALS

Powerful performance for heavy industry



The SKF brand now stands for more than ever before, and means more to you as a valued customer.

While SKF maintains its leadership as the hallmark of quality bearings throughout the world, new dimensions in technical advances, product support and services have evolved SKF into a truly solutions-oriented supplier, creating greater value for customers.

These solutions encompass ways to bring greater productivity to customers, not only with breakthrough application-specific products, but also through leading-edge design simulation tools and consultancy services, plant asset efficiency maintenance programs, and the industry's most advanced supply management techniques.

The SKF brand still stands for the very best in rolling bearings, but it now stands for much more.

SKF – The knowledge engineering company

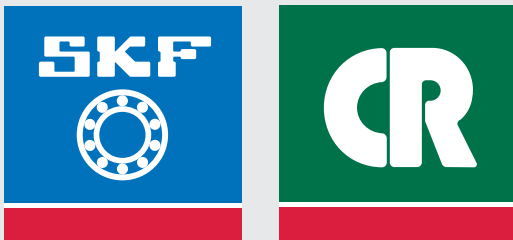

CONTENTS

CR Large Diameter Seals	4	Shaft requirements	28
General.....	4	General.....	28
Metal clad seal family	6	Tolerances	28
General	6	Surface finish	28
EP-2000 (HDS7)	7	Hardness and surface treatment	28
HDL seals	8	Large diameter wear sleeves, LDSLV	29
HDS1, HDS2 and HDS3	9	Lead-in chamfers	29
HD metal clad seal options	10	Housing bore requirements	30
HDSA, HDSB and HDSC	10	General.....	30
HDSD	11	Housing bores for seals with steel shells.....	30
HDSE.....	11	Housing bores and end covers for HS and HSF seals .	30
Available sizes.....	11	Tolerances	30
All-rubber seal family	12	Surface finish	30
General.....	12	Mounting large diameter seals	33
SBF seals	12	General.....	33
HDS4 and HDS6	13	Mounting split HS seals.....	34
Fabric-reinforced seals series HSF	14	Different ways of mounting HS seals.....	36
HS designs	15	Multiple seal installation	36
HS solid seal types	15	Paired mounting.....	36
HS3, HS4, HS5.....	15	Cover plates	37
HS split seal types	16	Large diameter wear sleeves LDSLV	38
HS6, HS7	16	General.....	38
HS8, HS9	17	Product features.....	39
Additional design features	18	Use	41
Spring connections for split seal types.....	18	Mounting	41
Spacer lugs	19	Dismounting	41
Spring-Lock	20	Product tables	42
Spring-Kover	20	HDL, metric sizes.....	42
Bore-Tite.....	20	HDL, inch sizes	44
Sealing lip materials	21	SBF, metric sizes	58
General	21	SBF, inch sizes	59
Nitrile rubber (R)	22	HSF1 (split), HSF5 (solid), metric sizes.....	60
Duralip (D)	22	HSF1 (split), HSF5 (solid), inch sizes	72
Duratemp (H).....	22	HSF2 (split), HSF6 (solid), metric sizes.....	77
LongLife (V)	23	HSF2 (split), HSF6 (solid), inch sizes	77
Polytetrafluoro-ethylene (PTFE)	23	HSF3 (split), HSF7 (solid), metric sizes.....	78
Seal selection chart	24	HSF3 (split), HSF7 (solid), inch sizes	84
Customized sealing solutions	26	HSF4 (split), HSF8 (solid), metric sizes.....	85
Size options of HDS metal clad seals.....	26	HSF4 (split), HSF8 (solid), inch sizes	85
HS seals.....	27	HSF9, metric sizes	86
Size listing of HDS4 and HDS6	27	HSF9, inch sizes	87
		SKF – The knowledge engineering company	88

CR LARGE DIAMETER SEALS

A wide range of sealing solutions for heavy industry

General

Heavy basic industries such as primary metals, construction, wind energy, forestry, mining and pulp and paper, provide a challenging environment for radial shaft seals. Operating in a wide range of speeds, temperatures and environmental conditions, shaft seals are asked to reliably retain lubrication while avoiding harsh contamination from penetrating and potentially damaging capital equipment. Generally, seals for shaft diameters larger than 200 mm or 8 in are known as large diameter seals (LDS).

CR LDS are available from SKF in a variety of heavy-duty styles, configurations and materials. Several large diameter designs are available: HD metal clad designs, including the HDL ultra-high performance series, the technologically advanced EP-2000 grease seal and the dependable HDS series; all-rubber seals like the premium SBF seal and the HSF fabric reinforced series, solid or split.





294 mm (11.575 in)

METAL CLAD SEAL FAMILY

Designed for heavy-duty applications

General

The most popular seal group in the CR LDS line is the metal clad seal family with the HD seal designs.

The HD designs include the highly engineered EP-2000, the ultra-high performance HDL and the reliable HDS1, HDS2 and HDS3 seal. CR HD seals are specifically designed to withstand the extreme condi-

tions encountered in heavy-duty applications.

The seals perform exceptionally well in the highly contaminated environment of metal rolling mills, the high speed and high temperature environment of paper mills, as well as more universal applications such as industrial gearboxes. The metal clad seal family has a product to perform in almost any industrial application.

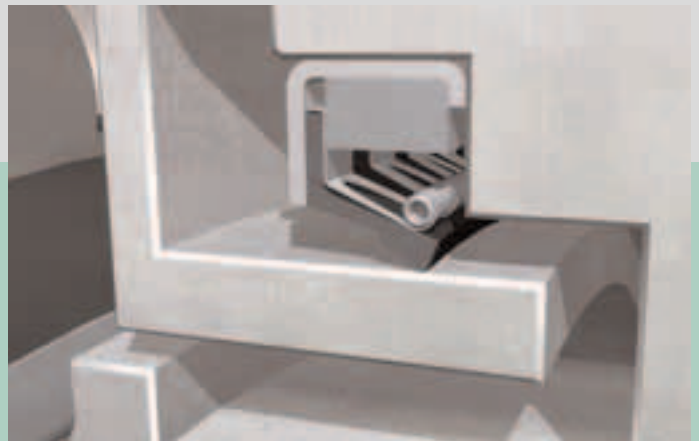

EP-2000 (HDS7)

The newest member of the HD seal family is the EP-2000 (“Extra Performance” construction type HDS7).

Water and solid contamination particles are common causes for bearing failures. CR has developed the EP-2000 as a grease seal with enhanced exclusion capabilities.

The highly engineered EP-2000 features a computer optimized, springless lip profile designed to retain lubricants and aggressively pump contamination away from the lip. The increased ability of the EP-2000 to exclude contamination makes it an ideal

equipment protector in heavily contaminated environments such as the water and scale present in rolling mill applications.

The springless lip concept of the EP-2000 also reduces radial load. Radial load can be thought of as the ‘squeeze’ force that the seal exerts on the shaft. High radial load can lead to increased seal wear and elevated underlip temperatures decreasing seal life.

Current customers are reporting easier installation, fewer seal replacements (translating into longer seal life) and an increase in process run time.

The EP-2000 is available in a nitrile lip material for common applications, Dura-temp® (**page 22**) for higher temperature conditions and Duralip® (**page 22**) for applications where extra abrasion resistance is necessary.

It is important to note that the EP-2000 is not available in LongLife® material (**page 23**).

The EP-2000 is available in all shaft sizes ranging from 200 to 1 575 mm (8 to 62 in). Spacer lugs are available for any configuration, see **page 19** for further information.

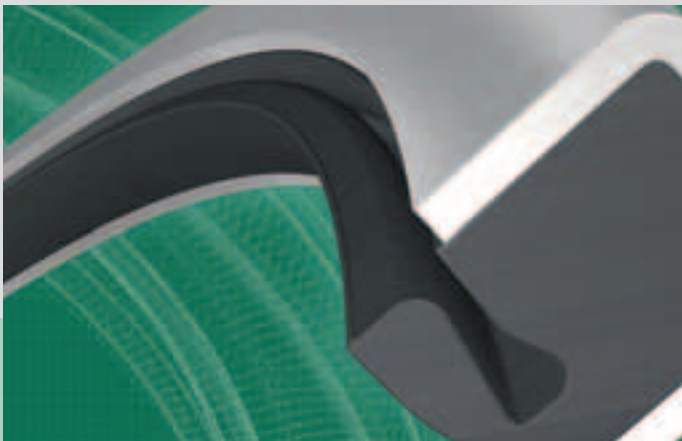

EP-2000 (HDS7)

HDL seals

The HDL is a premium metal clad oil seal that is especially designed to operate in severe conditions including high speeds and temperatures, high run-out and high misalignment. The excellent high-speed performance characteristics of the HDL make it the preferred design in the severe environment encountered in the rolls of the papermaking machines.

The HDL features a stainless steel garter spring that is entrapped by individual finger springs, also made of stainless steel, around the entire circumference of the seal.

The spring combination allows the seal to compensate for severe conditions in order to maintain high levels of sealing performance, operational life and equipment reliability.

The HDL is available in nitrile, Dura-temp and LongLife (**pages 22 and 23**), ensuring that the HDL will perform regardless of speed or temperature. Spacer lugs are available for all products within the HDL line. Available HDL sizes can be found in the product tables (**page 42 to 56**).

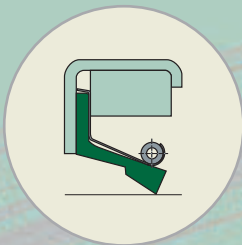
**HDL**

HDS1, HDS2 and HDS3

The most commonly used metal clad seal is the HDS series for general purpose applications. HDS seals are divided into the HDS1, HDS2 and HDS3 categories.

All three seal versions are encased in a heavy-duty steel shell and a SAE 302 series stainless steel spring is standard.

The basic HDS1 has its stainless steel spring mounted in a protective Spring-Lock groove. Where blind installations may increase the risk of spring displacement, the type HDS2 adds a Spring-Kover that bonds the spring into the groove. The HDS3 adds a spark-free inner diameter,

standard Duralip material and adjustable spacer lugs. The adjustable lugs are optional on all other HDS models, as are fixed width lugs (**page 19**).

The HDS seal product line is available in a wide variety of rubber materials in all sizes ranging from 200 to 1 575 mm (8 to 62 in) (**Table 1, page 26** and **Table 3, page 27**). Nitrile is standard on all HDS seals (with the exception of the HDS3 where Duralip is standard), however all seal types can also be ordered in Duralip, Duratemp or LongLife elastomers (**page 22** and **23**).

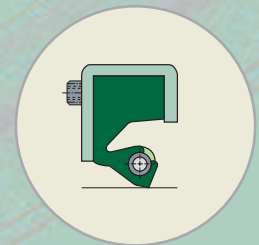
**HDS1****HDS2****HDS3**

HD metal clad seal options

For enhanced exclusion performance, the HD metal clad seals are available in different styles to best meet the needs of your application. Each style is primarily based on HDS1, HDS2, HDS3 or EP-2000 and is available with auxiliary elements for special applications.

HDSA, HDSB and HDSC

These seals are designed with a single rubber sealing element and an auxiliary exclusion element. For shaft sizes up to 550 mm (21.750 in), the excluder lip is made of Duralip material. Leather is used for larger shafts. These styles are generally used where there is insufficient space for more than one seal.

The HDSA, HDSB and HDSC seal product lines are available in sizes ranging from 203 to 1 016 mm (8 to 40 in) (**Table 1 on page 26**).



HDSA

HDSB

HDSC



HDSD

The HDSD seal types are designed with dual sealing elements with lips facing in opposite directions. This style is used for applications requiring the separation of two fluids. When using an HDSD seal, it is very important to provide a means to lubricate the sealing elements (i.e. the cavity between the sealing elements may be packed with grease or holes may be drilled from the outer diameter into the cavity between the lips).

HDSE

This style features dual elements with lips facing in the same direction. This seal type is used where a back-up seal is desired for retention or exclusion purposes. As with the HDSD type, a means of lubricating the seals is necessary for a proper sealing function.

Available sizes

The HDSD and HDSE seal product lines are available in sizes ranging from 203 to 1 346 mm (8 to 53 in) (**Table 1 on page 26**).

**HDSD****HDSE**

ALL-RUBBER SEAL FAMILY

Rubber covered designs

General

The CR family of all-rubber seals includes metal inserted (SBF), fabric-reinforced (HSF) and all-rubber (HS) products. The fabric-reinforced and all-rubber versions are available as solid round or with an open joint or split.

The all-rubber seal family offers designers and operators of rotating equipment a number of important operating and installation benefits. All-rubber seals do not score the bore even after repeated installations and extractions. This prevents damage to the metal that can cause bypass

leakage. All-rubber seals accept rougher bore finishes, reducing machining costs. They are especially helpful for split housings. They resist corrosion and will not seize in the bore even years after assembly.

Due to lower press-in forces, rubber covered seals are often easier to install particularly in the field or confined spaces. They can be fitted by hand or with simple hand tools even when the diameters are very large. Further, in the case of split seals there is no need to dismount the shaft or other machine components.

SBF seals

The SBF seal design is a new rubber OD seal with a flexible metal stiffening ring that allows mounting without the use of a cover plate. The SBF seal can be used as an upgrade to rubber fabric seals in many applications that are either grease or oil lubricated. The SBF seals are available in both NBR and LongLife (FKM) materials with optional Spring-Kover (**page 20**).

Available SBF sizes can be found in the product tables (**page 58 to 59**).

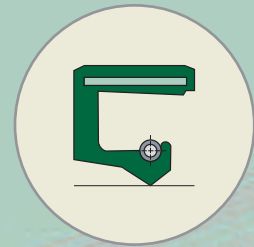

SBF



HDS4 and HDS6

Also new are two rubber covered seals, the HDS4 and HDS6. The HDS4 features a patented molded-in garter spring, which cannot be displaced during difficult installations and provides superior oil sealability while minimizing wear. The HDS6 is a springless version designed for grease retention and contamination exclusion. Nitrile rubber is standard and can be ordered in the full range of HDS rubber compounds.

Both HDS4 and HDS6 are equipped with moulded 12,7 mm (0.5 in) spacer lugs, which can be trimmed or removed if necessary. The HDS4 and HDS6 are stocked in a limited range of sizes; see **Table 3** on **page 27** or contact us for information on availability and new size additions.

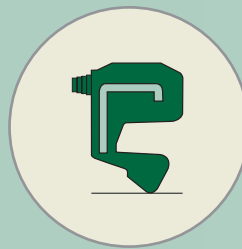
**HDS4****HDS6**

Fabric-reinforced seals series HSF

The HSF seal types consist of the HSF5, HSF6, HSF7 and HSF8 solid seal styles and their split versions HSF1, HSF2, HSF3 and HSF4. There is also a pressure profile HSF9 in solid version only. These seal styles are mainly used in heavy-duty applications such as gear drives, propeller shafts, cold and hot mill work rolls, pumps, paper machinery, etc.

The HSF5, HSF6 and HSF7 are fabric-reinforced seals that have a strong, flexible, textile rubber back instead of a metal case. The HSF5 is the standard single lip rubber fabric seal. The HSF6 adds radial lubrication grooves in the back of the seal and the HSF7 adds a circumferential lubri-

cation groove. The HSF8 offers a dust-lip version of the standard seal.

To attain optimum sealing performance, a retaining or cover plate is necessary to properly install and apply all HSF seal types. The plate creates an axial preload that ensures reliable static sealing performance of the seal. The plate should also be designed to avoid seal distortion upon assembly. The HSF seal types are available in NBR and FKM material.

Available HSF sizes can be found in the product tables (**page 60 to 87**).

*HSF5 (solid)
HSF1 (split)*



*HSF6 (solid)
HSF2 (split)*



*HSF7 (solid)
HSF3 (split)*



HS designs

Type HS seals, available in solid round and split designs, are all-rubber, large diameter seals designed without an outer shell or metal case. Some types are available in solid and split designs. The HS style seals featured in this brochure are HS3, HS4, HS5, HS6, HS7, HS8 and HS9, see **Table 1, page 18**.

HS solid and split large diameter seals are cataloged by shaft size and priced by the dimensions of the bore for which they are designed. The actual seal outside diameter is approximately 0,5 % to 2 % larger than the seal housing bore. Actual seal width is approximately 0,4 to 0,8 mm (0.016 to 0.031 in) wider than the bore depth. A cover plate is required to compress the seal within the cavity, helping seal the split joint and prevent leakage.

A garter-type spring embedded in the sealing element reinforces lip pressure against the shaft.

HS solid seal types

HS solid seals can be made as standard types from 203 mm (8 in) up to unlimited shaft size. There are three types:

HS3

HS3 seals are all-rubber solid seals with a single spring-loaded element. The spring is held in an open groove; Spring-Kover is not available. HS3 is recommended for vertical and horizontal shafts. For proper fit, a cover plate is required.

HS4

HS4 seal is an all-rubber solid seal with a single spring-loaded element. It features a Spring-Lock (page 20) and is recommended for vertical and horizontal shafts. For proper fit, a cover plate is required.

HS5

HS5 is the same as HS4 with the addition of a Spring-Kover (page 20) for added protection against spring pop-out and contamination.

The HS solid seal product line is available in sizes ranging from 203 to 4 572 mm (8 to 180 in) (**Table 2 on page 27**).

**HS3****HS4****HS5**

HS split seal types

Where downtime is critical and shaft removal is impractical, type HS all-rubber split seals are ideal. They are simply placed around the shaft and pushed into the seal bore, then held firmly by a cover plate, which compresses the split joint together. HS split seals perform best with grease or heavy lubricants as well as with light lubricants, placed no higher than the shaft centre-line. Horizontal shafts are preferred with the split placed in the 12 o'clock position. HS split seals are available in a wide variety of types, styles and materials.

HS6

HS6 is an all-rubber split seal with a single spring-loaded element and a Spring-Lock (page 20). HS6 features a separate loose spring and a positive spring connection. Generally, the spring connection is of the hook-and-eye type for shafts over 457 mm (18 in) and a threaded-type connection for smaller sizes. For proper fit, a cover plate is required.

HS7

HS7 is an all-rubber split seal with a single spring-loaded element, which has both a Spring-Lock and a Spring-Kover (page 20). A control-wire spring connector is used to join the seal together (see figure below). HS7 does not have the high performance as other HS types, but it is the easiest to install. The spring is completely enclosed and the connection is simply made by running the control wire into the center of the spring coil across the split (butt joint). Spring tension to hold the sealing lip on the shaft is built-in at the factory. For proper fit, a cover plate is required. Due to the unique design that permits easier installation, please note that a gap may occur at the joint even after the cover plate is installed. Special attention to place the gap at the 12 o'clock position during installation is necessary.



HS6



HS7



Seal control wire feature, used on HS7

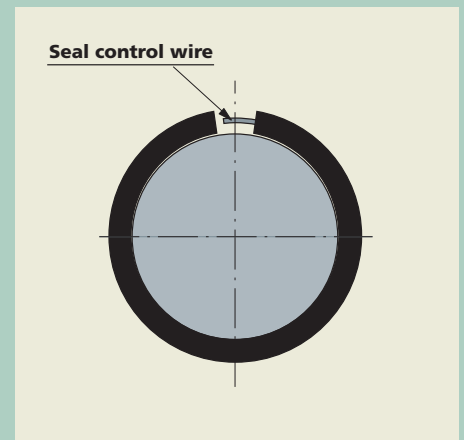

HS8

HS8 is an all-rubber split seal with a single spring-loaded element, Spring-Lock, Spring-Kover (**page 20**) and a positive spring connection. The spring is entirely enclosed except for a small portion on either side of the split. HS8 provides the most positive seal of all the split types and is the preferred design for use with lighter lubricant retention and water exclusion. HS8 performs best on horizontal shafts, but may also be used on vertical shafts. For proper fit, a cover plate is required.

HS9

HS9 is the same as HS3 except that HS9 is a split design. HS9 is not available with Spring-Kover. It is recommended for grease retention on horizontal shafts. For proper fit, a cover plate is required. The HS9 has limited size availability. For new applications, HS8 is recommended.

The HS split seal product line is available in sizes ranging from 203 to 4 572 mm (8 to 180 in) (**Table 2 on page 27**).

**HS8****HS9**

ADDITIONAL DESIGN FEATURES

Spring connections for split seal types
 The SAE 302 stainless steel garter springs are supplied loosely (separately) in the HS6 and HS9 styles. The springs are factory-installed and encased with Spring-Kover (page 20) in the HS7 and HS8 styles. In styles HS6, HS8 and HS9, the spring connection is generally of the hook-and-eye type for shafts over 457 mm (18 in) in diameter (fig 1) and of the threaded type for smaller sizes (fig 2). It is recommended for sealing light oils as well as heavy greases.

The special control-wire type is available only in the HS7 design for all shaft sizes and recommended for grease only. Where positive spring connections are made, the connection should be offset to the left or right of the split for maximum efficiency.

Hook-and-eye spring connection



Threaded spring connection



HS seals selection chart

Features		Solid types			Split types			Table 1
		HS3	HS4	HS5	HS6	HS7	HS8	HS9
Spring groove type		Open groove	Spring-Lock	Spring-Lock	Spring-Lock	Spring-Lock	Spring-Lock	Open groove
Spring connection		Factory made	Factory made	Factory made	Threaded/Hook-and-Eye	Control wire	Threaded/Hook-and-Eye	Threaded/Hook-and-Eye
Spring-Kover		Not available	None	100% covered	None	100% covered	Covered except ends	Not available
Ability to seal light lubes		Good	Good	Good	Good	Poor	Good	Fair
Misalignment tolerance (STBM)	mm in	1,57 0.062	1,57 0.062	1,57 0.062	1,57 0.062	1,57 0.062	1,57 0.062	1,57 0.062
Eccentricity tolerance (TIR)	mm in	2,36 0.093	2,36 0.093	2,36 0.093	2,36 0.093	2,36 0.093	2,36 0.093	2,36 0.093
Maximum speed	m/s ft/min	10,1 2 000	15,2 3 000	12,7 2 500	10,1 2 000	7,6 1 500	10,1 2 000	7,6 1 500
Pressure tolerance		Fair	Good	Good	Poor	Poor	Poor	Poor

Spacer lugs

Spacer lugs may be furnished on all metal clad designs to separate seals in multiple installations and provide space for lubrication. (fig 3).

The traditional fixed-width lugs are 9,5 mm (0.375 in) in diameter and are available in widths from 4,9 mm (0.125 in) to 12,7 mm (0.5 in) in increments of 1,6 mm (0.0625 in). The fixed-width lug is an available option on all metal clad seals except HDS3. All HDS3 style seals come standard with adjustable lugs. This new concept allows the user to adjust lug widths on the spot to suit individual requirements.

All adjustable lugs are 9,5 mm (0.375 in) in diameter and 12,7 mm (0.5 in) in width. They may be adjusted to smaller widths in 1,6 mm (0.0625 in) increments simply by

removing the steel washers. Also, the lugs may be removed entirely.

Certain small cross sections may require special narrow diameter 5,33 mm (0.210 in) lugs with a width range of 1,6 to 3,2 mm (0.0625 to 0.125 in)

The lugs are placed around the heel of the seal in four, six or eight equally-spaced locations, depending on the seal outer diameter (Table 2).

Number of spacer lugs needed

Table 2				
Spacer lugs pcs.	Seal outer diameter from mm		to incl. in	
	from mm	incl. mm	from in	incl. in
4		762		30
6	762	1 143	30	45
8	1 143		45	

Spacer lug



Fig 3

Spring-Lock

Spring-Lock is a sealing lip feature that surrounds 270° of the garter spring's diameter (**fig 4**). The Spring-Lock helps hold the spring in position during seal handling, installation and removal. It is standard on all HDS and HS seals (except for the HS3 and HS9 styles which have an open groove).

Spring-Kover

In applications where dirt, water or other contaminants may pose serious problems or where installation could jar the spring out of place, CR Spring-Kover can be specified. Spring-Kover is a flexible covering over the exposed portion of the stainless steel garter spring (**fig 5**). It protects the spring without adversely affecting the spring's capability. Spring-Kover is available on all seals except HS3 and HS9.

Bore-Tite®

Bore-Tite is a water based acrylate sealant that is an option available on most CR metal clad seals. The sealant is used as a coating on the outside diameter of the seal (**fig 6**). The Bore-Tite layer is pliable with a thickness of 0,03 to 0,07 mm (0.0012 to 0.0028 in), allowing the sealant to help fill small imperfections in the housing bore. Bore-Tite can be used at temperatures up to 200 °C (392 °F) and is compatible with most oils, greases, aqueous acids and alkalis, alcohols and glycols. Please note that Bore-Tite is not compatible with aromatics, ketones and esters. Incidental contact with these substances will have little to no effect if wiped off quickly.

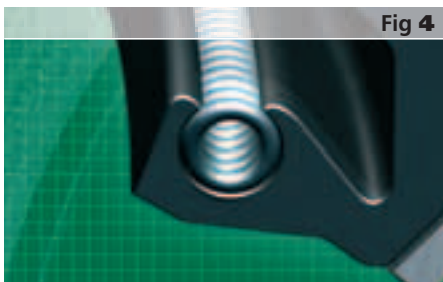
Spring-Lock*Spring-Kover**Bore-Tite*

SEALING LIP MATERIALS

General

In addition to seal design, the seal lip material significantly contributes to seal performance and reliability.

CR seals are therefore produced as standard with a variety of materials for the sealing lip, shell (casing) and garter spring, to cater for the different demands of applications.

The sealing lips of CR seals are generally made of elastomer materials. However, thermoplastic materials such as polytetrafluoro-ethylene (PTFE) are gaining in importance. PTFE is mainly used for special seals intended for particular applications where there are demands for high thermal or chemical resistance. Seals made from leather or felt are now seldom used.

CR Large Diameter Seals are generally produced from the materials listed in **Table 1**. These materials have characteristic properties making them particularly suitable for specific applications; they are briefly described in the following.

By changing the actual formulation and blending it is possible to modify the characteristics of elastomers regarding

- resistance to swelling,
- elasticity,
- chemical resistance,
- thermal resistance,
- behavior in the cold,
- gas permeability.

Details about the chemical resistance of the seal materials to the various media encountered in operation will be found in the section “Chemical resistance”, page 27 in CR Publication 457010.

A code is used to identify the material of the sealing lip of CR seals, see table below. The codes also appear in the designations of the metric radial shaft seals. For seals where a combination of materials is used, a combination of the code letters is used, e.g. RD (nitrile rubber with Duralip).

Table 1

Composition of basic material	Designation according to		
	CR	ISO1629 ISO1043.1 DIN 7728 Part 1	ASTM D1418 ASTM D1600
Acrylonitrile butadiene rubber (nitrile rubber)	R	NBR	NBR
Hydrogenated acrylonitrile butadiene rubber (Duratemp)	H	HNBR	NEM
Carboxylated nitrile rubber (Duralip)	D	X-NBR	X-NBR
Fluoro rubber (LongLife)	V	FPM	FKM
Polytetrafluoro-ethylene (PTFE)	T	PTFE	PTFE

Sealing lip materials

Nitrile rubber (R)

The term nitrile rubber is used in this catalog for acrylonitrile butadiene rubber. This material has very good engineering properties and is the universal seal material. It is a copolymer produced from acrylonitrile and butadiene. It shows good resistance to the following media:

- most mineral oils and greases with a mineral oil base,
- normal fuels: gasoline, diesel and light heating oils,
- animal and vegetable oils and fats and hot water.

It also tolerates short-term dry running of the sealing lip. The permissible operating temperature range is -50 to $+100$ °C (-58 to $+212$ °F); for brief periods temperatures of up to $+120$ °C ($+248$ °F) can be tolerated. At higher temperatures the material hardens.

CR Duralip (D)

Duralip is a carboxylated nitrile rubber developed by CR, which combines the good technical properties of nitrile rubber with a particularly high resistance to wear. It is mainly used for large seals having a bore diameter of 200 mm (8 in) or more. Seals of this material should be chosen when abrasive substances such as sand, soil, scale etc. could reach the surface on which the sealing lip runs.

CR Duratemp (H)

Duratemp is a hydrogenated nitrile rubber, which has appreciably improved wear resistance compared to nitrile rubber so that seals made of Duratemp have longer life. Duratemp is also more resistant to heat, aging and hardening in hot oil or ozone. Mixtures of oil in air may have a negative effect. The upper operating temperature limit is $+150$ °C ($+302$ °F), which is appreciably higher than that of ordinary nitrile rubber. Duratemp is suitable for large radial shaft seals.



CR LongLife (V)

LongLife is characterised by its high thermal and chemical resistance. Its resistance to aging and ozone is also very good and its gas permeability is very slight.

CR LongLife seals have exceptionally good properties even under harsh environmental conditions and can withstand operating temperatures of up to +200 °C (+392 °F). The seals are also resistant to oils and hydraulic fluids, fuels and lubricants, mineral acids and aliphatics as well as aromatic hydrocarbons which would cause seals made of other materials to fail. They will also tolerate dry running of the lip for short periods. The seals should not be used in the presence of esters, ethers, ketones, certain amines and hot anhydrous hydrofluorides. Because of their useful properties, CR produces seals in LongLife material for all common shaft diameters from 200 mm to 1 575 mm (8 to 62 in).

At temperatures above +300 °C (+572 °F), fluoro elastomers give off dangerous fumes. This can occur, for example, if a welding torch is used when dismantling a bearing. Although the fumes are only produced at high temperatures, once heated, the seals will be dangerous to handle even when they have cooled down.

If it is necessary to handle fluoro elastomer seals, which have been subjected to excess temperatures, the following should be observed:

- protective goggles and gloves should always be worn;
- the remains of seals should be put in an airtight plastic container which should be marked with a suitable symbol “material will etch”;
- respect the information given on the appropriate safety data sheet

If there is unintentional contact, hands should be washed with soap and plenty of water and water should also be used as an eye bath. A doctor should always be consulted. This also applies if, during heating of the seals, the vapors have been inhaled. SKF takes no responsibility for the improper handling of fluoro elastomer seals nor for any injury resulting therefrom. The user is responsible for the correct use of the product during its service life and its proper disposal.







































Polytetrafluoro-ethylene (PTFE)

PTFE is a thermoplastic polymer. The chemical resistance is far superior to that of any other material. The operating temperature range extends from –70 to +200 °C (–94 to +392 °F) and may go up to +260 °C (+500 °F). The effects of overheating are as described under CR LongLife.

PTFE has a smooth dirt-resistant surface and a very low coefficient of friction. The seals will tolerate dry running and also provide insulation against the passage of electric current.

CR seals of PTFE, or with PTFE sealing lips are made to special order and represent tailored solutions to specific problems.



Standard design (preferred design)	Other basic line designs	Lip code	Operating temperature range	
			°C	°F
 HDS7	  HDS6 HDS4	R D H	-40 to +121 -54 to +107 -40 to +149	-40 to +250 -65 to +225 -40 to +300
 HDL	 HDLA	R H V	-40 to +121 -40 to +149 -40 to +204	-40 to +250 -40 to +300 -40 to +400
 SBF		R V	-40 to +121 -40 to +204	-40 to +250 -40 to +400
 HDS2	  HDS1 HDS3	R D H V	-40 to +121 -54 to +107 -40 to +149 -40 to +204	-40 to +250 -65 to +225 -40 to +300 -40 to +400
 HDSA2	     HDSA1 HDSB2 HDSB1 HDSC2 HDSC1	R D H V	-40 to +121 -54 to +107 -40 to +149 -40 to +204	-40 to +250 -65 to +225 -40 to +300 -40 to +400
 HDSE2	   HDSE1 HDSD2 HDSD1	R D H V	-40 to +121 -54 to +107 -40 to +149 -40 to +204	-40 to +250 -65 to +225 -40 to +300 -40 to +400
 HS Solid	   HS5 HS3 HS4	R D H V	-40 to +121 -54 to +107 -40 to +149 -40 to +204	-40 to +250 -65 to +225 -40 to +300 -40 to +400
 HS Split	  HS6 HS9	R D H V	-40 to +121 -54 to +107 -40 to +149 -40 to +204	-40 to +250 -65 to +225 -40 to +300 -40 to +400
  HS7 HS8				
 HSF Solid	     HSF5 HSF6 HSF7 HSF8 HSF9	R V	-40 to +121 -40 to +204	-40 to +250 -40 to +400
 HSF Split	    HSF1 HSF2 HSF3 HSF4	R V	-40 to +121 -40 to +204	-40 to +250 -40 to +400

Pressure tolerance	Shaft to bore misalignment (STBM)	Maximum shaft dynamic run-out (DRO)	Maximum shaft surface speed	Ease of installation	Ability to seal light lubes and excluding water
MPa (PSI)	mm (in)	mm (in TIR)	m/s (ft/min)		
0,07 to 0,103 (10 to 15)	1,57 (0.062)	2,36 (0.093)	25,4 (>5 000) depending on operating conditions	Excellent	Highly effective exclusion of water and particle contamination and excellent retention of grease
0,07 to 0,103 (10 to 15)	2,5 (0.098)	2,36 (0.093)	25,4 (5 000) nitrile and Duratemp 35,5 (7 000) LongLife rubber	Good	Excellent, including retention of light oils at high surface speeds and misalignment
0,07 to 0,103 (10 to 15)	1,5 (0.060)	2,36 (0.093)	25,4	Excellent	Excellent for oil and grease
0,07 to 0,103 (10 to 15)	1,57 (0.062)	2,36 (0.093)	25,4 (>5 000)	Excellent (HDS2, HDS3) Good (HDS1)	Excellent for oil and grease
0,07 to 0,103 (10 to 15)	1,57 (0.062)	2,36 (0.093)	25,4 (>5 000)	Excellent too good, varies with equipment design	Excellent for oil or grease with exclusion of light to moderate contamination (HDSA/B). Good grease retention with increased protection from contamination (HDSC).
0,07 to 0,103 (10 to 15)	1,57 (0.062)	2,36 (0.093)	25,4 (>5 000)	Excellent (HDSD & HDSE2) Good (HDSD & HDSE1)	Excellent for oil or grease with exclusion of light to moderate contamination (HDSD) or separation of dual media. Good grease retention with increased protection from contamination (HDSE).
0,07 to 0,103 (10 to 15) for HS4 & HS5 HS3 to 0,03 (5)	1,57 (0.062)	2,36 (0.093)	HS3 10,2 (2 000) HS4 15,2 (3 000) HS5 12,7 (2 500)	Excellent (HS4, HS5) Good (HS3)	Excellent (HS4, HS5) Good (HS3)
Not recommended	1,57 (0.062)	2,36 (0.093)	HS6 10,2 (2 000) HS7 7,62 (1 500) HS8 10,2 (2 000) HS9 7,62 (1 500)	Fair (HS6, HS9) Excellent (HS7) Good (HS8)	Good to excellent for oil or grease (HS6, HS8) Good (grease only HS7) Fair to good (HS9)
0,03 Max (5)	1,5 (0.060)	2,36 (0.093)	15,2 (>3 000) Depending on the operating conditions	Good to excellent depending on mounting space	Excellent
Not recommended	1,5 (0.060)	2,36 (0.093)	15,2 (>3 000) depending on the operating conditions	Fair to good depending on mounting space	Good to excellent

CUSTOMIZED SEALING SOLUTIONS

Size options of HDS metal clad seals

CR offers a wide range of LDS products to provide the right seal for optimum performance in the hottest, fastest and most extreme environments in modern industry. To accommodate almost every application, HDS seal designs are available on a “made-to-order basis”.

Please see **Table 1** for the available sizes and cross sections of the different types and contact us for further information about delivery time.

Preferred standard metal clad seals sections

Table 1

Seal type	Bore diameter ¹		Shaft size ²		Difference between bore and shaft		Width	
	from	to	from	to	from	to	from	to
–	mm (in)							
HDS7	234,95 9.250	1 638,30 64.500	203,20 8.000	1 574,80 62.00	31,75 1.250	63,5 2.500	15,88 0.625	31,75 1.250
HDS1, HDS2, HDS3	234,34 9.226	1 651 65.000	203,20 8.000	1 574,80 62.000	31,14 1.226	76,20 3.000	15,88 0.625	38,01 1.500
HDSA, HDSB, HDSC	234,34 9.226	1 092 43.000	203,20 8.000	1 016 40.000	31,14 1.226	76,20 3.000	22,23 0.875	38,10 1.500
HDSD, HDSE	234,43 9.226	1 346 53.000	203,20 8.000	1 346 53.000	31,14 1.226	76,20 3.000	31,75 1.250	50,80 2.000

¹⁾ Bore tolerance H8 ²⁾ Shaft tolerance h11



Size options of HS seals

HS seal sizes are not listed in this brochure but are available in standard cross sections and widths according to **Table 2**. For other cross sections please contact us for availability.

Size listing of HDS4 and HDS6

The rubber covered HDS4 and HDS6 seals are currently stocked in the range of sizes listed in **Table 3**. Please contact us for availability and new size additions.

Size options of HS seals

Difference between bore and shaft	Bore diameter ¹		Shaft diameter ²		Bore depth ³
	from	to	from	to	
mm (in)					
25,40 1.000	228,60 9.000	1 854 73.000	203,20 8.000	1 829 72.000	12,70; 15,88 0.500; 0.625
31,75 1.250	234,95 9.250	1 301 51.250	203,20 8.000	1 829 50.000	15,88 0.625
38,10 1.500	279,40 11.000	4 610 181.500	241,30 9.500	4 572 180.00	15,88; 17,48; 19,05 0.625; 0.688; 0.750
50,80 2.000	330,00 13.000	4 622 182.000	279,40 11.000	4 572 180.000	20,70 0.815

1) Bore tolerance H8 2) Shaft tolerance h11 3) Tolerance ±0,1

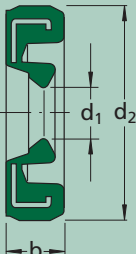
					
Dimensions			Dimensions		
d ₁	d ₂	b	d ₁	d ₂	b
mm			in		
406,4	457,2	20,65	16.000	18.000	0.813
419,1	469,9	20,65	16.500	18.500	0.813
457,2	508	22,2	18.000	20.000	0.875
533,4	584,2	19,05	21.000	23.000	0.750
558,8	609,6	22,23	22.000	24.000	0.875
698,5	749,3	22,23	27.500	29.500	0.875

Available sizes of HDS4 and HDS6

SHAFT REQUIREMENTS

General

To achieve reliable sealing and sufficiently long service life, the counterface for radial shaft seals on the shaft should meet the requirements outlined in the following. The counterface is considered to be the extent of the surface of a shaft, or sleeve mounted on a shaft, over which the edge of the sealing lip can run, taking into account all permissible deviations and movements – surface “SL”, (Table 1), as well as an additional surface SL' which may be required in the case of repairs or inspection.

Tolerances

The diameter of the shaft d_1 at the counterface should be machined to the tolerances given in Tables 2 and 3.

If components which are to be mounted with an interference fit are to be passed over the counterface the shaft diameter should be reduced by 0,2 mm. The seal which was originally chosen can still be used without its sealing properties being impaired.

Surface finish

The surface roughness to ISO 4288 (DIN 4768) of the counterface for radial shaft seals should be kept within the following limits:

- R_a 0,2 to 0,8 μm
- R_z 1 to 4 μm
- R_{max} 6,3 μm

The lower values for R_a and R_z are minimum values as otherwise lubricant supply to the sealing lip will be affected. The temperature rise caused by inadequate lubrication, particularly at high circumferential speeds, would lead to hardening and cracking of the lip and thus to premature seal failure. If the surfaces are too rough there

will be excessive seal lip wear and seal life will be shortened. If the value R_{max} is exceeded leakage may occur.

It is also important that the machining operation does not leave any directionality behind on the counterface, as this could lead to leakage by pumping action, depending on the direction of rotation. A suitable surface can be achieved by plunge grinding; whole number ratios of the grinding wheel speed to the workpiece speed should be avoided. The grinding wheel should be dressed using a cluster head dressing tool and the smallest possible lateral feed, or a profile dressing roll without lateral feed. The negative influence of directionality in any particular case only be ascertained by test running under conditions of alternating rotation.

The counterface should be free of any damage such as bruises, scratches, cracks, rust or raised sections. It is therefore important that it be properly protected until final mounting takes place. Such protect-

ion can, for instance, be provided by threading a cardboard tube over the counterface, or preferably over the whole shaft.

Hardness and surface treatment

The surface hardness of the counterface should normally be at least 55 HRC or 600 HV and the hardened depth should be at least 0,3 mm. Under certain conditions, e.g. where speeds are low, lubrication good and contamination absent, counterfaces having a lower hardness than 55 HRC may be suitable. Surfaces which are nitrided, phosphated or have a galvanised layer may also be suitable in special cases, but this must be determined for each specific case.

Large diameter wear sleeve, LDSLV

In case the counterface cannot meet the demands outlined above, the use of a CR LDSLV is recommended. These wear sleeves are made of stainless steels, chrome plated with a hardness of ≈ 50 HRC and a surface roughness R_a or 0,25 to 0,5 μm .

Table 1

Seal width		Counterface ¹⁾			
b		e ₁	e ₂	e ₃	e ₄
from	incl.		min		min
mm		mm			
7	7,938	3,5	6,1	1,5	7,6
–	8	3,5	6,8	1,5	8,3
9,525	10	4,5	8,5	2	10,5
11,112	12	5	10	2	12
–	12,7	5	11	2	13
14,288	15	6	12	3	15
20	–	9	16,5	3	19,5

¹⁾ SL' \approx washer width

Counterfaces for standard radial shaft seals

Detailed information on the LDSLV is found in the section starting on **page 38**.

Lead-in chamfers

In order to be able to install radial shaft seals without damaging the seal lip it is recommended that the shaft ends or shoulders should be chamfered or rounded (**Table 4**).

If the direction of installation is according to Z the values given in **Table 4** should be kept to. If the direction of installation is Y then the shaft end may be either rounded or chamfered.

If seals are to be installed over shaft shoulders or ends which have not been rounded or chamfered it is recommended that a mounting sleeve be used. For further information, please contact our technical department.

Counterface tolerances for metric seals

Shaft diameter		Diameter tolerance (h11) Deviation		Circularity tolerance (IT8) Deviation
Nominal d ₁ over	incl.	high	low	max
mm		µm		µm
180	250	0	-290	72
250	315	0	-320	81
315	400	0	-360	89
400	500	0	-400	97
500	630	0	-440	110
630	800	0	-500	125
800	1 000	0	-560	140
1 000	1 250	0	-660	165
1 250	1 600	0	-780	195
1 600	2 000	0	-920	230
2 000	2 500	0	-1 100	280
2 500	3 150	0	-1 350	330
3 150	4 000	0	-1 650	410

Counterface tolerances for inch-size seals

Shaft diameter		Diameter tolerance (h11) Deviation		Circularity tolerance (IT8) Deviation
Nominal d ₁ over	incl.	high	low	max
in		in		in
-	4	+0.003	-0.003	0.002
4	6	+0.004	-0.004	0.002
6	10	+0.005	-0.005	0.003

Shaft shoulder chamfers and radii

Shaft diameter		Diameter difference ¹⁾	Radii	
Nominal d ₁ over	incl.	d ₁ - d ₃	Seal without dust lip R min	Seal with dust lip R min
mm		mm		
130	240	7	1	2
240	500	11	2	3
500		13	5	5

¹⁾ If the corner is blended rather than chamfered, the blended section should not be smaller than the difference in diameters d₁ - d₃

HOUSING BORE REQUIREMENTS

General

The following requirements are designed to guarantee the requisite interference fit for the seal, the necessary static sealing and proper installation.

Housing bores for seals with steel shells

To ensure that the seal can be installed without damaging it, the housing bore should have a 5 to 10° lead-in chamfer. The transition should be free from burrs and the transition between the seal seating and the shoulder should have a radius not exceeding 0,8 mm.

The depth of the housing bore (t_2) should be at least 0,3 mm greater than the seal width b . The cylindrical section (t_1) of the bore should have a width of at least 0,85 b , (fig 2).

Recesses in the housing shoulder, which must be considered at the design stage, considerably facilitate removal of a seal from the housing bore, (Table 1).

Housing bores and end covers for HS and HSF seals of elastomers

To ease installation and prevent damage to the seals during mounting, the housing bore should have a lead-in chamfer of 5 to 10°, fig 2. The transition should be free of burrs and the transition between seal seating and housing shoulder should have a radius which does not exceed $R = 0,8$ mm.

In contrast to the other radial shaft seals the non-split and split HS and HSF seals must be axially clamped in the housing bore. This is usually achieved by an end cover screwed to the housing wall. The real width of the seal is between 0,4 and 0,8 mm larger than the nominal width of the seal housing groove (t_2). The axial clamping so achieved gives the HS and HSF seal the requisite firm fit in the housing and the correct form for efficient sealing.

The actual seal outside diameter is approximately 0,5 % to 2 % larger than the seal housing bore.

The end cover should be sufficiently thick-walled, depending on diameter and the axial clamping distance, wall thicknesses of between 6 and 12 mm have been found appropriate. The cover should be screwed to the machined housing wall following the recommendations given in fig 13. To provide additional protection to the sealing lip against coarse contaminants the inside diameter of the cover should be some 6 to 8 mm larger than the shaft diameter d_1 . There are no limits regarding the outside diameter of the cover. To ease mounting and any subsequent seal replacement, it is recommended that the cover be made in two halves and an even number of screws used.

The end face should be made plane parallel and the machined housing wall should be at right angles to the housing bore.

Tolerances

The bore diameter d_2 in the housing should be machined to tolerance H8 (Table 1). The circularity (out-of-round) should be 1 to 2 tolerance grades better than H8, depending on the conditions.

Surface finish

The surface roughness (to ISO 4288 or DIN 4768) of the housing bore should be kept within the limits specified below. These limits apply for radial shaft seals with an elastomeric outside diameter, or a

metal case coated with Bore-Tite, as well as the HS seals made of elastomer.

R_a 1,6 to 6,3 μm

R_z 10 to 25 μm

R_{max} 25 μm

For seals with a steel shell without Bore-Tite or similar coating, the limits are

R_a 0,8 to 3,2 μm

R_z 6,3 to 10 μm

R_{max} 10 μm

Recommended dimensions for HS seals

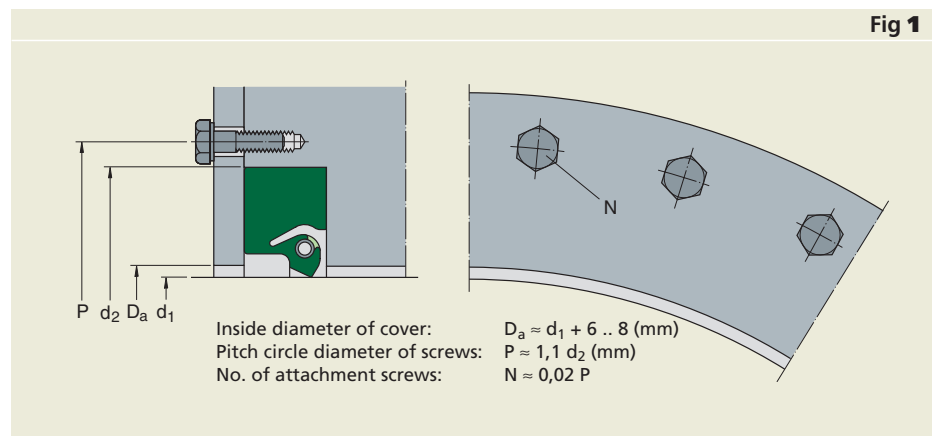

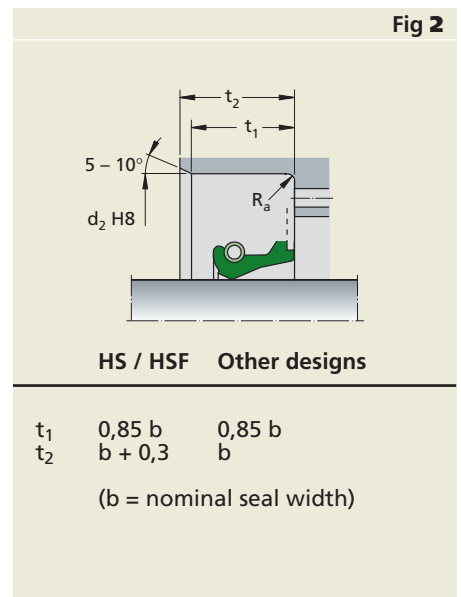

Recommended dimensions for HS seals

Housing bore tolerances

Table 1

Housing bore for metric size seals					Housing bore for inch size seals				
Nominal diameter d ₂	Housing bore (ISO tolerance H8)		Chamfer R max		Nominal diameter d ₂	Housing bore		Chamfer R max	
	over	incl.				Deviation high	low		
mm	µm		mm		in	in		in	
180	250	+72	0	0,8	6	10	+0.002	-0.002	1/32
250	315	+81	0	0,8	10	20	+0.002	-0.004	1/32
315	400	+89	0	0,8	20	40	+0.002	-0.006	1/32
400	500	+97	0	0,8	40	60	+0.002	-0.010	1/32
500	630	+110	0	0,8					
630	800	+125	0	0,8					
800	1 000	+140	0	0,8					
1 000	1 250	+165	0	0,8					
1 250	1 600	+195	0	0,8					
1 600	2 000	+230	0	0,8					
2 000	2 500	+280	0	0,8					
2 500	3 150	+330	0	0,8					
3 150	4 000	+410	0	0,8					
4 000	5 000	+500	0	0,8					



MOUNTING LARGE DIAMETER SEALS

General

For the installation of large diameter metal or rubber-covered seals such as the HDS designs, first check the bore for proper specification and condition. Second, coat both the seal and bore lightly with lubricant (preferably the same lubricant as that to be retained by the seal). With large diameter seals the production of a special mounting tool may not be practical. In such cases, direct impacts on the seal case or elements must be avoided, as this could damage the case or make the sealing lip unserviceable. Therefore, if no suitable press tool is avail-

able, the use of a wooden block, long enough to span the seal outer diameter, is recommended. It is important, when using this method, that hammer blows are applied evenly and sequentially to the wood piece around the seal circumference, to prevent the seal from tilting or skewing. CR also recommends the use of a dead blow hammer for full energy transfer with less shock (**fig 1**).

In some applications, the hardware is designed for two seals in tandem, or a seal might have to be recessed further into the bore depth. In those cases the seal is first

set flush with the housing using the method above. Then a shorter piece of wood should be used to drive it deeper into the bore utilizing a sequential pattern (**fig 2**).

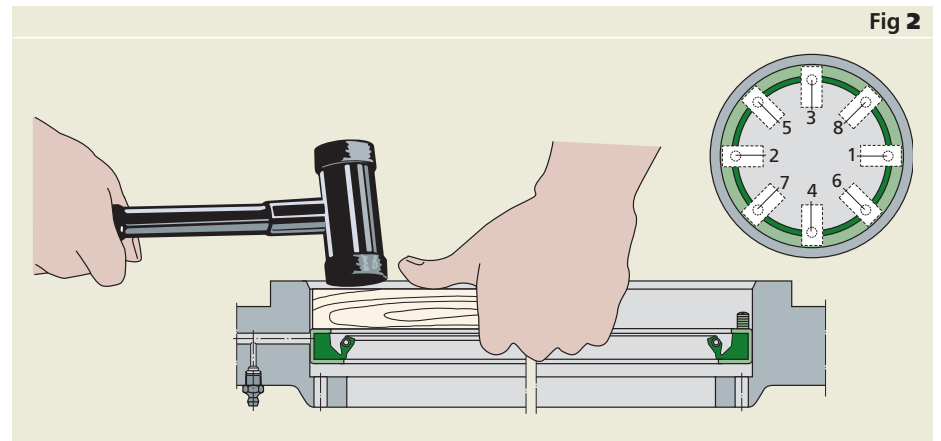
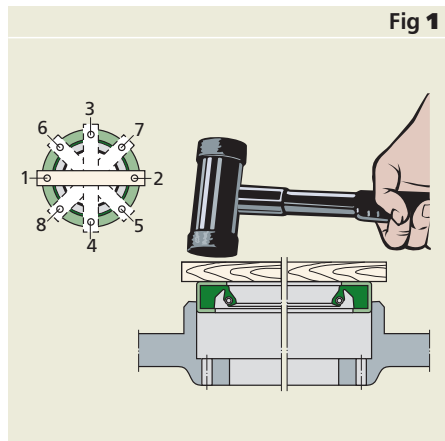

Mounting split HS seals

Coat the HS seal and shaft counterface with lubricant, preferably the same as that to be retained by the seal (**A**, **fig 3**).

Where appropriate, insert the spring in the Spring-Lock groove and position the spring connection, so that it is displaced with regard to the seal joint (**B**).

Put the HS seal in the correct position on the shaft. If necessary and if portable vulcanisation equipment is available, use this to join the ends of the HS seal, making sure that the ends are accurately aligned (**C**).

Join the ends of the garter spring in two different ways depending on the type of spring connector (**D**):

Threaded spring connector: Turn the spring ends through approximately three turns, one in the opposite direction to the other. Insert the one end into the other and, because they have already been turned, the ends will screw into position. Further tightening is possible if required, although the connection will hold even if the thin section is not completely screwed into the other end.

Hook-and-eye spring connector: Draw the ends of the spring together and insert the hook into the eye, taking care not to over-stretch the spring in the process, as this might impair seal performance. Springs with control wire connector: draw the ends of the seal together and insert the control wire into the other end of the spring.

Position the seal joint on the shaft so that it is in the 12 o'clock position and push the joint into the housing bore (**E**).

Starting at the 3 and 9 o'clock positions, push the rest of the seal into position (**E**), finishing simultaneously at the 6 and 12 o'clock positions. For shaft diameters of 1 200 mm (47 in) and above it may be preferable to fix the seal in the 12, 3, 6 and 9 o'clock positions before pushing home the remaining sections of the seal.

The seal in the housing bore is pushed until it contacts the housing shoulder, e.g. using a small block of wood.

Check the seal condition, particularly at the joint.

Put the end cover in position on the housing wall using the screws. Tighten the screws in turns, tightening opposite screws together, until the end cover abuts the housing wall (**F** and **G**).

Fig 3

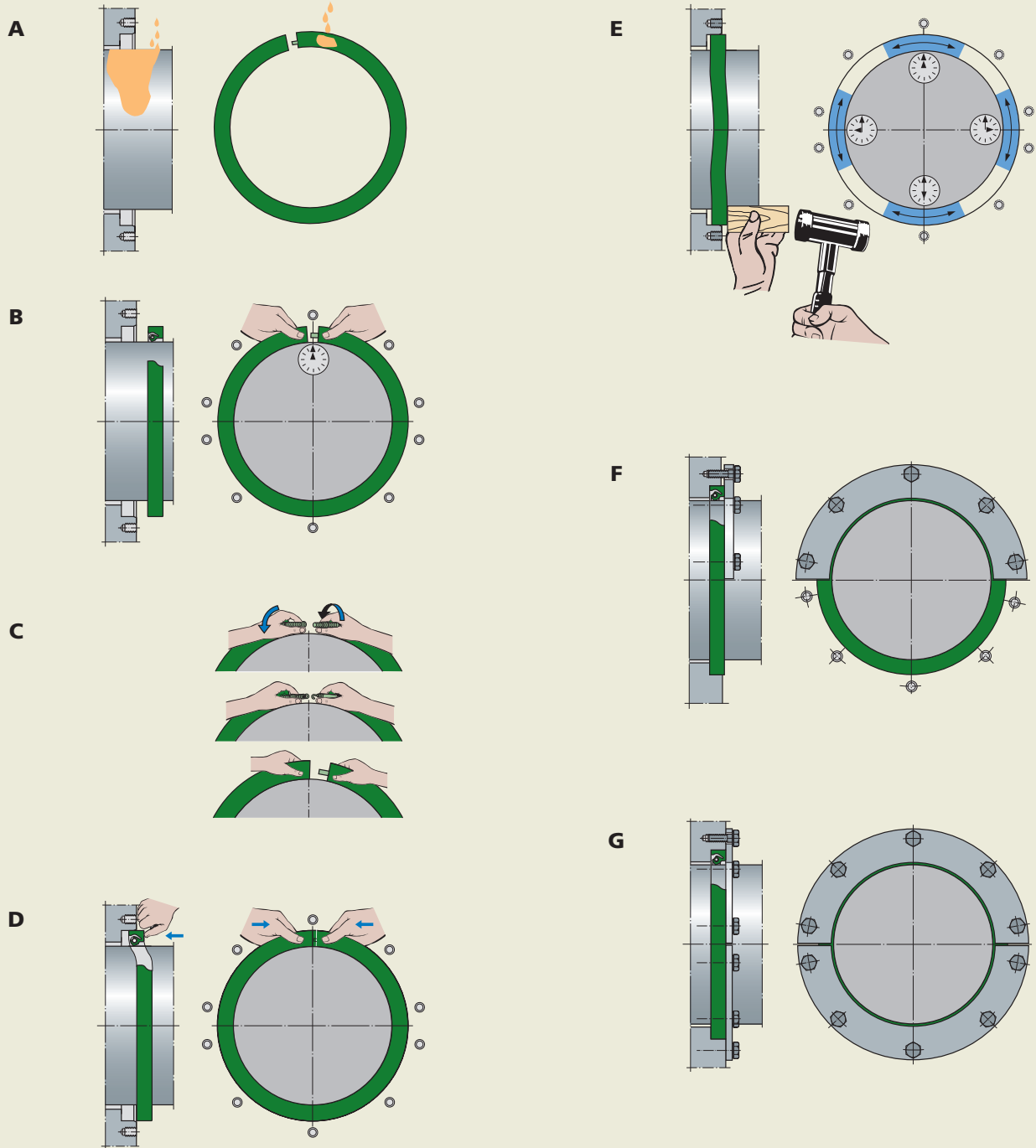

Different ways of mounting HS seals

HS seals are mounted in different ways depending on which purpose they are supposed to fulfil. They can e.g. either be mounted to retain lubricants or to exclude foreign materials (fig 4).

Multiple seal installation

When mounting two split seals in one cavity, the locations of the split joints should be staggered 30° to 60°. This will minimize the risk of leakage through the joint. The splits should be located towards the top of the bore. Grease the cavity between the seals to provide lip lubrication for the outer seal.

Paired mounting

If two radial shaft seals are to be mounted in a common housing bore either in tandem or in a back-to-back arrangement, care must be taken to see that neither of the sealing lips can run dry at any time. To eliminate any risk of dry running, the free

space between the seals or sealing lips should be filled with a suitable lubricating grease.

To guarantee lubricant supply to the sealing lips in operation and to prevent dry running, the use of a spacing ring between the two seals is recommended. This ring should be provided with lubrication holes (fig 5), so that grease can be supplied to the space between the sealing lips, e.g. via a grease nipple. No spacer ring is required when using HDS3 seals as these have spacer lugs built into the large side face (fig 6).

Where two HS seals made of elastomer are to be mounted in the same housing bore it has been found advantageous to mount a spacing washer between the two seals (fig 7 and 8). Suitable washer dimensions can be determined based on the inside and outside diameters of the seal, d_1 and d_2 respectively:

washer inside diameter
= $d_1 + 6$ to 10 mm

washer outside diameter
= $d_2 - 0,5$ to 1,5 mm

The washer width must be determined with reference to the conditions but should always be such that lubrication holes can be provided in the circumference, or lubrication grooves in one side face (fig 9) to permit grease to be supplied from outside to the sealing lips, e.g. via a grease nipple. When determining washer width and the depth of the housing bore it is also necessary to take into consideration the axial displacement required when clamping the seals.

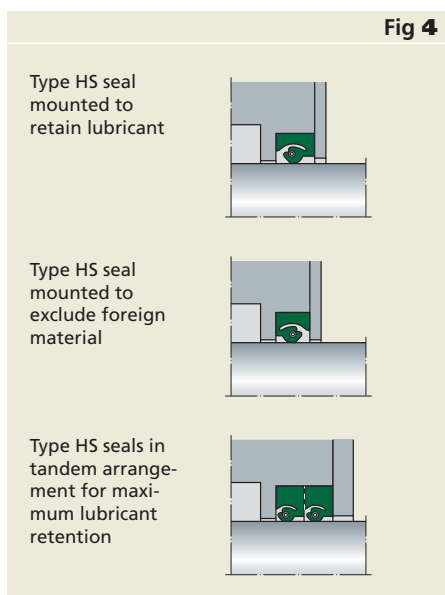
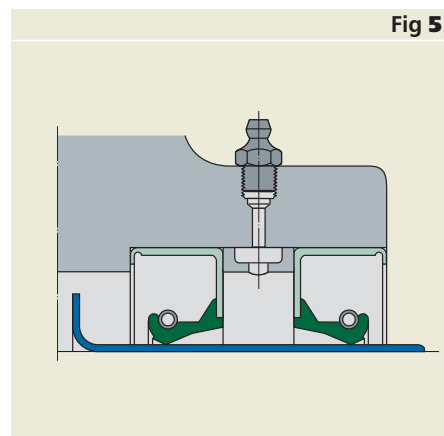
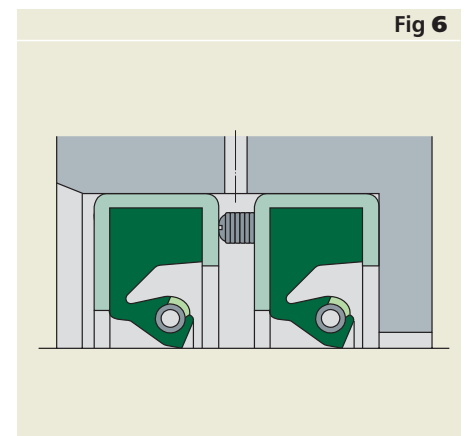
Examples of HS seal applications**Spacing ring****Spacer lugs**

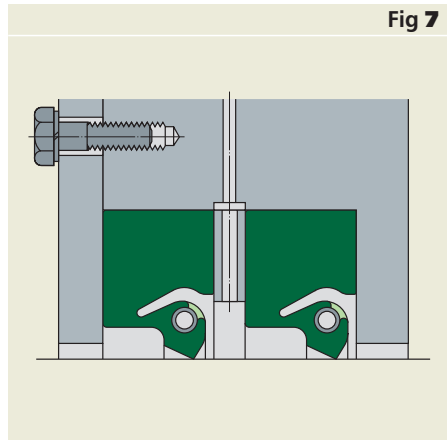

Fig 7

Cover plates

All HS type seals, split and solid are 0,4 to 0,8 mm (0.016 to 0.031 in) wider than the bore depth and have outside diameters that are 2 % to 5 % larger than the seal housing bore. The end user is required to fabricate and use a cover plate for proper fit. The cover plate provides axial compression and supplements radial press fit to ensure maximum seal performance. It should be thick enough not to bend or distort. Generally, a thickness of 6,35 to 12,7 mm (0.250 to 0.500 in) is sufficient.

The plate should be secured with bolts, no more than 150 mm (6 in) apart, on a bolt circle located as close to the seal housing bore as practical. The cover plate should be flat and the housing bore depth uniform. Splitting the cover plate at 180° will make

seal replacement easier, particularly in confined areas.

To block surges of lubricant towards the seal from the inside and to protect the seal from damage from the outside, it is recommended that the cover plate inner diameter be as close as practical to the shaft. Generally, 6,35 mm (0.250 in) over shaft diameter is sufficient in the presence of shaft misalignment and run out.

Sometimes, supplementary sealing needs to be added. It is impractical to machine the original housing to provide the seal cavity required. In such instances, the seal cavity may be incorporated into a new plate, which is bolted into place as illustrated (fig 10).

Spacing washer

Spacing washer

Details of spacer for central lubrication

A separator between two seals can be a slotted washer to provide lubrication circulation.

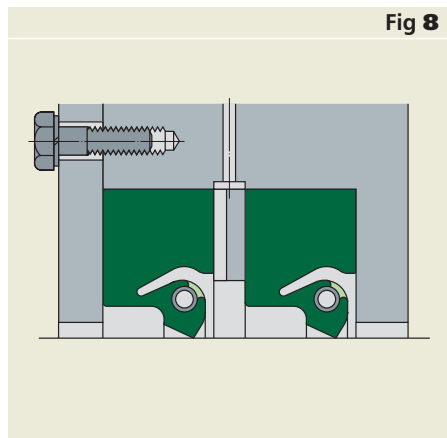

Fig 8

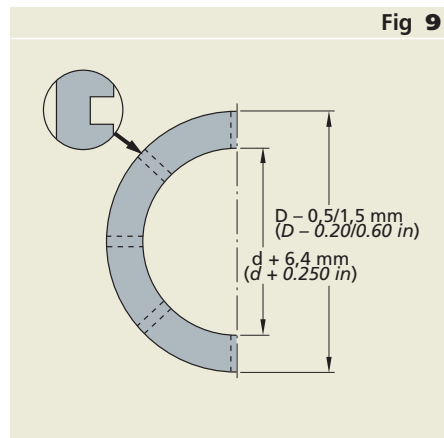

Fig 9

New seal cavity plate

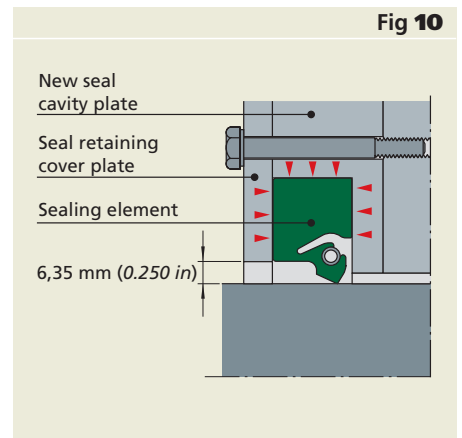

Fig 10

LARGE DIAMETER WEAR SLEEVES

General

Large Diameter Wear Sleeves, (LDSL), are used primarily for applications where no Speedi-Sleeve is available, i.e. for shafts in the diameter range 203 to 1 150 mm (8 to 45 in). Two designs of LDSLV are produced: the LDSLV3 with a flange (**fig 1**) and the flangeless LDSLV4 (**fig 2**). Their use is recommended in all cases where the operating conditions for the seals are difficult, particularly where solid contaminants can reach the seal lip, e.g. in rolling mills and chemical plants. These are

cases where seal wear and damage of the counterface on the shaft can be expected.

It is recommended that LDSLV are designed into the application from the outset. During repairs, it will then not be necessary to rework the shaft and the original seal size can always be used as the replacement.

LDSL3 with a flange

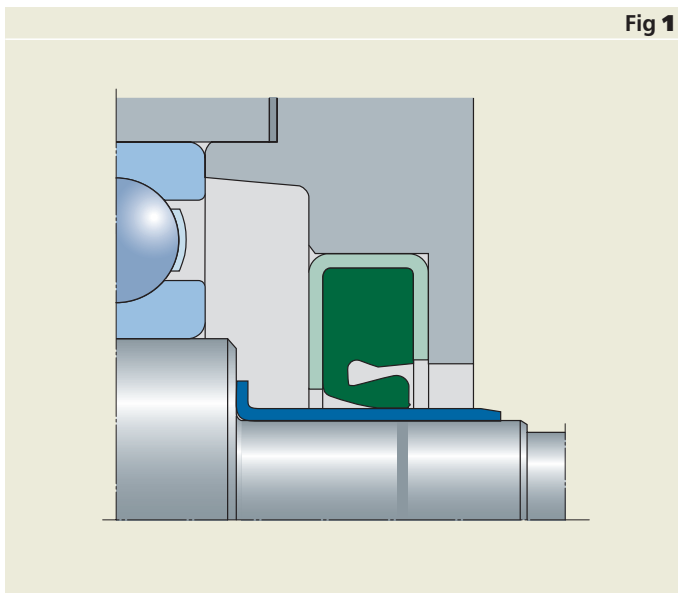

Product features

LDSLVS are made of stainless steels, chrome plated with a hardness of ≈ 50 HRC and a surface roughness R_a of 0,25 to 0,5 μm . The wall thickness of the standard sleeves is 2,54 mm (0.100 in). The sliding surface for the seal is fine machined and chromium plated to enhance the wear and corrosion resistance.

The width of the counterface for the seal on the LDSLV3 is 6,4 mm (0.250 in) narrower than the total width B of the sleeve. The flange height is 12,7 mm (0.500 in) for all sizes. Details of the possible diam-

eters and widths of the sleeves will be found in **Table 1, page 40**, together with the sleeve and shaft tolerances.

LDSLVS4 are intended for applications where a flange (to ease mounting) is in the way, or where a wider sliding surface for the seal is required. The dimensions, tolerance recommendations etc. are otherwise the same as those quoted for the LDSLV3.

Flangeless LDSLV 4

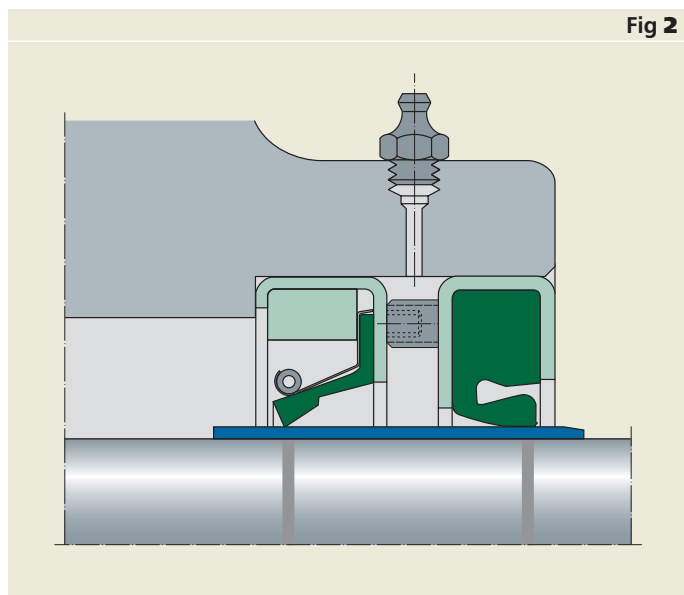
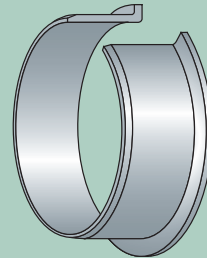
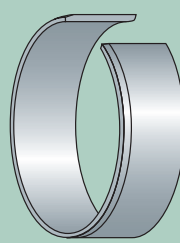
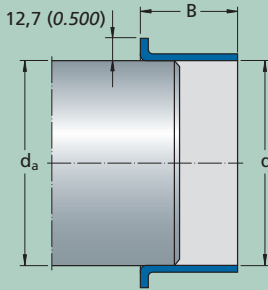

Table 1



LDSLV3

LDSLV4

Diameter nominal		Sleeve bore diameter d		Width b	Shaft diameter d _a		Probable interference			
d over	incl.	deviation high	deviation low		min LDSLV3	min LDSLV4	deviation high	deviation low	min	max
mm/in		µm		mm/in	µm		µm			
203,2 8	304,8 12	-127	-305	63,5 2.500	17,5 0.680	12,7 0.500	+50	-50	+57	+355
304,8 12	508 20	-150	-400	63,5 2.500	17,5 0.680	12,7 0.500	+100	-50	+100	+500
508 20	762 30	-150	-400	63,5 2.500	17,5 0.680	12,7 0.500	+200	-50	+100	+600
762 30	1 016 40	-150	-400	63,5 2.500	25,4 1.000	19,05 0.750	+200	-50	+100	+600
1 016 40		-150	-450	63,5 2.500	25,4 1.000	19,05 0.750	+250	-50	+100	+700

Please contact us for recommendations concerning Large Diameter Wear Sleeves that will operate in systems with sustained oil sump temperatures of 75 °C (170 °F) and speeds in excess of 20 m/s (4 000 ft/min).

Use

There are two alternative ways of using LDSLV for shaft repairs. Either the sleeve can be pushed along the shaft until it covers the damaged part and a seal which has a 4,8 mm (0.180 in) larger bore diameter than the original is used, or the shaft can be machined down 4,8 mm (0.180 in) and the original seal size used. The reworked shaft seating for the sleeve should have a surface roughness value of between 2,5 and 3,2 $\mu\text{m R}_a$ (100 to 125 μin)

Mounting

LDSLV are mounted with an interference fit on the shaft. It is therefore recommended that they are heated prior to mounting. Temperatures of up to 180 °C (356 °F) are permitted; on no account should the sleeve be heated (to) above 200 °C (392 °F). The types of heating arrangements normally used for bearings are suitable, e.g. heating cabinets, oil baths or induction heaters.

The thin-walled sleeves should be mounted immediately after heating as they cool rapidly. This is particularly true of the LDSLV4.

Dismounting

To dismount the sleeves it is recommended first to either heat them or to expand them by light hammer blows. The flange of the LDSLV3 should first be cut through at one point.

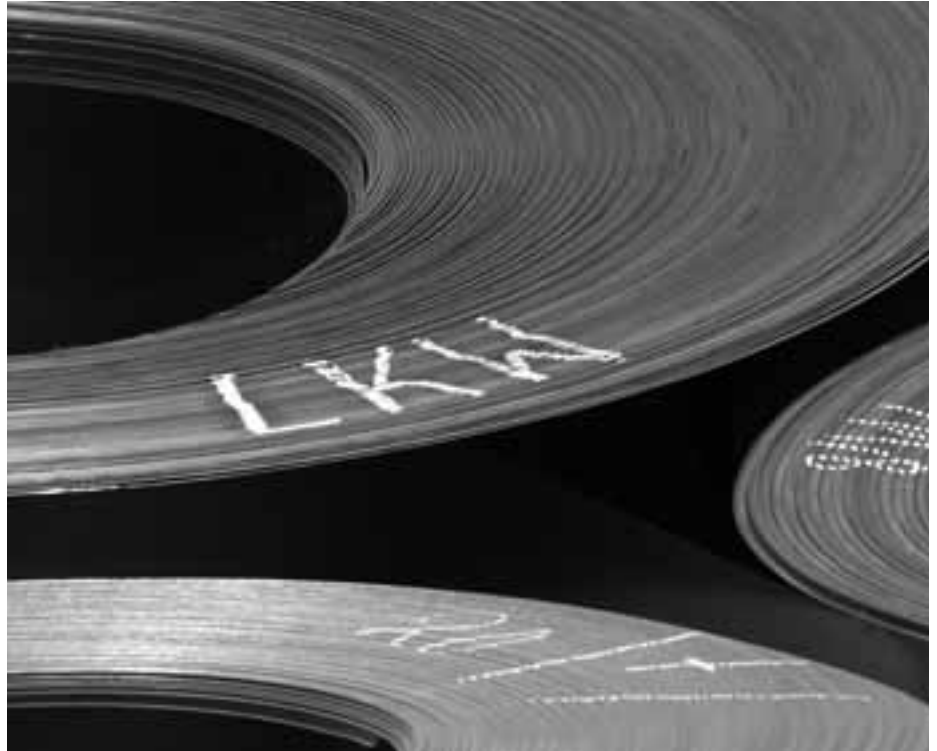

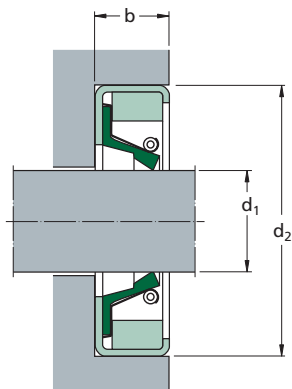

Housing dimensions				Lip material	SKF designation	Housing dimensions				Lip material	SKF designation
shaft	bore	width				shaft	bore	width			
d ₁	d ₂	b			d ₁	d ₂	b				
mm				–	mm				–		
200	240	20		R V	CR 200×240×20 HDL R CR 200×240×20 HDL V	440	480	20		R V	CR 440×480×20 HDL R CR 440×480×20 HDL V
220	250	18		R V	CR 220×250×18 HDL R CR 220×250×18 HDL V	470	520	22		R V	CR 470×520×22 HDL R CR 470×520×22 HDL V
232	269,87	17,45		R V	CR 232×269.87×17.45 HDL R CR 232×269.87×17.45 HDL V	480	520	20		R V	CR 480×520×20 HDL R CR 480×520×20 HDL V
240	270	15		R V	CR 240×270×15 HDL R CR 240×270×15 HDL V	485	535	19		R V	CR 485×535×19 HDL R CR 485×535×19 HDL V
240	280	20		R V	CR 240×280×20 HDL R CR 240×280×20 HDL V	500	550	19		R V	CR 500×550×19 HDL R CR 500×550×19 HDL V
270	308	17,45		R V	CR 270×308×17.45 HDL R CR 270×308×17.45 HDL V	508	560	25		R V	CR 508×560×25 HDL R CR 508×560×25 HDL V
280	320	19,98		R V	CR 280×320×19.98 HDL R CR 280×320×19.98 HDL V	513	543	16		R V	CR 513×543×16 HDL R CR 513×543×16 HDL V
280	340	20,62		R V	CR 280×340×20.62 HDL R CR 280×340×20.62 HDL V	520	560	18		R V	CR 520×560×18 HDL R CR 520×560×18 HDL V
330	370	18		R V	CR 330×370×18 HDL R CR 330×370×18 HDL V	520	570	22		R V	CR 520×570×22 HDL R CR 520×570×22 HDL V
360	404	17,45		R V	CR 360×404×17.45 HDL R CR 360×404×17.45 HDL V	530	580	20,62		R V	CR 530×580×20.62 HDL R CR 530×580×20.62 HDL V
390	430	16		R V	CR 390×430×16 HDL R CR 390×430×16 HDL V	540	590	24,98		R V	CR 540×590×24.98 HDL R CR 540×590×24.98 HDL V
400	450	17,45		R V	CR 400×450×17.45 HDL R CR 400×450×17.45 HDL V	560	610	20		R V	CR 560×610×20 HDL R CR 560×610×20 HDL V
400	440	20		R V	CR 400×440×20 HDL R CR 400×440×20 HDL V	565	601	20		R V	CR 565×601×20 HDL R CR 565×601×20 HDL V
420	460	17,45		R V	CR 420×460×17.45 HDL R CR 420×460×17.45 HDL V	600	640	20		R V	CR 600×640×20 HDL R CR 600×640×20 HDL V
420	470	17,45		R V	CR 420×470×17.45 HDL R CR 420×470×17.45 HDL V	630	670	20		R V	CR 630×670×20 HDL R CR 630×670×20 HDL V
420	460	20		R V	CR 420×460×20 HDL R CR 420×460×20 HDL V	640	680	20		R V	CR 640×680×20 HDL R CR 640×680×20 HDL V

Type HDL is also available on request with dust lip (HDLP Type) and with execution for high pressure (HDLHP Type).

Housing dimensions				Lip material	SKF designation	Housing dimensions				Lip material	SKF designation
shaft	bore	width				shaft	bore	width			
d ₁	d ₂	b			d ₁	d ₂	b				
mm				–		mm				–	
650	714	25		R V	CR 650×714×25 HDL R CR 650×714×25 HDL V	1 350	1 415	25		R V	CR 1350×1415×25 HDL R CR 1350×1415×25 HDL V
668	706	25,4		R V	CR 668×706×25.4 HDL R CR 668×706×25.4 HDL V	1 380	1 440	25		R V	CR 1380×1440×25 HDL R CR 1380×1440×25 HDL V
750	814	25		R V	CR 750×814×25 HDL R CR 750×814×25 HDL V						
760	804	18		R V	CR 760×804×18 HDL R CR 760×804×18 HDL V						
780	844	25		R V	CR 780×844×25 HDL R CR 780×844×25 HDL V						
790	854	25		R V	CR 790×854×25 HDL R CR 790×854×25 HDL V						
837	889	22,22		R V	CR 837×889×22.22 HDL R CR 837×889×22.22 HDL V						
838,1	881	20		R V	CR 838.1×881×20 HDL R CR 838.1×881×20 HDL V						
840	904	25		R V	CR 840×904×25 HDL R CR 840×904×25 HDL V						
920	958,01	19,05		R V	CR 920×958.01×19.05 HDL R CR 920×958.01×19.05 HDL V						
930	980	22,22		R V	CR 930×980×22.22 HDL R CR 930×980×22.22 HDL V						
990	1 040	25		R V	CR 990×1040×25 HDL R CR 990×1040×25 HDL V						
1000	1 050	22,22		R V	CR 1000×1050×22.22 HDL R CR 1000×1050×22.22 HDL V						
1 055	1 100	25		R V	CR 1055×1100×25 HDL R CR 1055×1100×25 HDL V						
1 105	1 160	22		R V	CR 1105×1160×22 HDL R CR 1105×1160×22 HDL V						
1 350	1 414	22		R V	CR 1350×1414×22 HDL R CR 1350×1414×22 HDL V						

Type HDL available on request also with dust lip (HDLP Type) and with execution for high pressure (HDLHP Type).

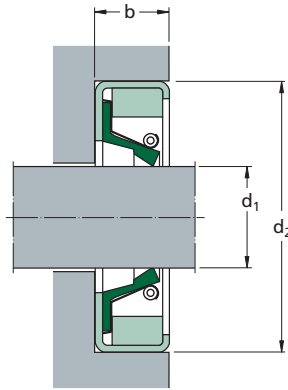

Housing dimensions			Designation		Housing dimensions			Designation	
shaft	bore	width	Lip material	V	shaft	bore	width	Lip material	V
d ₁	d ₂	b	R		d ₁	d ₂	b	R	
in (mm)			-		in (mm)			-	
6.125 155,57	7.625 193,67	0.687 17,45	CR HDL 1299 R	CR HDL 1299 V	9.000 228,60	10.500 266,70	0.687 17,45	CR HDL 3954 R	CR HDL 3954 V
						11.000 279,40	0.812 20,62	CR HDL 3955 R	CR HDL 3955 V
7.125 180,97	8.250 209,55	0.750 19,05	CR HDL 3011 R	CR HDL 3011 V	9.125 231,77	10.625 269,87	0.687 17,45	CR HDL 3957 R	CR HDL 3957 V
7.875 200,02	9.375 238,12	0.687 17,45	CR HDL 9176 R	CR HDL 9176 V		11.125 282,57	0.812 20,62	CR HDL 3962 R	CR HDL 3962 V
8.000 203,20	9.500 241,30	0.687 17,45	CR HDL 3921 R	CR HDL 3921 V	9.250 234,95	10.750 273,05	0.687 17,45	CR HDL 3963 R	CR HDL 3963 V
8.125 206,37	10.125 257,17	0.687 17,45	CR HDL 9712 R	CR HDL 9712 V		11.250 285,75	0.687 17,45	CR HDL 9706 R	CR HDL 9706 V
8.250 209,55	10.250 260,35	0.812 20,62	CR HDL 4499 R	CR HDL 4499 V	9.375 238,12	11.375 288,92	0.812 20,62	CR HDL 4610 R	CR HDL 4610 V
8.375 212,72	9.875 250,82	0.687 17,45	CR HDL 3933 R	CR HDL 3933 V	9.500 241,30	10.750 273,05	0.562 14,28	CR HDL 3145 R	CR HDL 3145 V
	10.375 263,52	0.812 20,62	CR HDL 4500 R	CR HDL 4500 V		11.250 285,75	0.750 19,05	CR HDL 3981 R	CR HDL 3981 V
8.500 215,90	9.750 247,65	0.562 14,28	CR HDL 1705 R	CR HDL 1705 V		11.500 292,10	0.812 20,62	CR HDL 3984 R	CR HDL 3984 V
	9.750 247,65	0.652 16,56	CR HDL 6384 R	CR HDL 6384 V	9.750 247,65	11.125 282,57	0.562 14,28	CR HDL 1692 R	CR HDL 1692 V
	10.000 254,00	0.687 17,45	CR HDL 8453 R	CR HDL 8453 V		11.250 285,75	0.687 17,45	CR HDL 3985 R	CR HDL 3985 V
	10.500 266,70	0.812 20,62	CR HDL 3938 R	CR HDL 3938 V		11.750 298,45	0.687 17,45	CR HDL 9425 R	CR HDL 9425 V
8.625 219,07	10.125 257,17	0.687 17,45	CR HDL 3939 R	CR HDL 3939 V	10.000 254,00	11.500 292,10	0.687 17,45	CR HDL 3992 R	CR HDL 3992 V
	10.260 260,60	0.687 17,45	CR HDL 2736 R	CR HDL 2736 V		11.750 298,45	0.750 19,05	CR HDL 3994 R	CR HDL 3994 V
	10.750 273,05	0.812 20,62	CR HDL 7718 R	CR HDL 7718 V		12.000 304,80	0.812 20,62	CR HDL 3997 R	CR HDL 3997 V
8.750 222,25	10.250 260,35	0.687 17,45	CR HDL 3946 R	CR HDL 3946 V		12.000 304,80	0.875 22,22	CR HDL 3998 R	CR HDL 3998 V
	10.500 266,70	0.687 17,45	CR HDL 9911 R	CR HDL 9911 V		12.250 311,15	0.812 20,62	CR HDL 3669 R	CR HDL 3669 V
	10.750 273,05	0.812 20,62	CR HDL 3952 R	CR HDL 3952 V	10.125 257,17	11.625 295,27	0.687 17,45	CR HDL 3999 R	CR HDL 3999 V
8.875 225,42	10.875 276,22	0.812 20,62	CR HDL 3953 R	CR HDL 3953 V		11.750 298,45	0.687 17,45	CR HDL 5989 R	CR HDL 5989 V

Type HDL is also available on request with dust lip (HDLP Type) and with execution for high pressure (HDLHP Type).

Housing dimensions			Designation		Housing dimensions			Designation		
shaft	bore	width	Lip material	V	shaft	bore	width	Lip material	V	
d ₁	d ₂	b	R		d ₁	d ₂	b	R		
in (mm)			–		in (mm)			–		
10.250 260,35	11.750	0.687	CR HDL 4004 R	CR HDL 4004 V	11.250 285,75	12.750	0.687	CR HDL 4527 R	CR HDL 4527 V	
	298,45	17,45				323,85	17,45			
	12.250	0.812	CR HDL 4009 R	CR HDL 4009 V		13.250	0.687	CR HDL 8778 R	CR HDL 8778 V	
	311,15	20,62				336,55	17,45			
10.500 266,70	12.500	0.812	CR HDL 4015 R	CR HDL 4015 V	11.375 288,92	13.250	0.812	CR HDL 4047 R	CR HDL 4047 V	
	317,50	20,62				336,55	20,62			
	12.000	0.687	CR HDL 4011 R	CR HDL 4011 V		13.375	0.812	CR HDL 4052 R	CR HDL 4052 V	
	304,80	17,45				339,72	20,62			
10.750 273,05	12.500	0.812	CR HDL 4017 R	CR HDL 4017 V	11.500 292,10	13.000	0.687	CR HDL 4057 R	CR HDL 4057 V	
	317,50	20,62				330,20	17,45			
	12.250	0.687	CR HDL 4023 R	CR HDL 4023 V		13.500	0.812	CR HDL 4063 R	CR HDL 4063 V	
	311,15	17,45				342,90	20,62			
10.875 276,22	12.500	0.875	CR HDL 4033 R	CR HDL 4033 V	11.750 298,45	13.250	0.687	CR HDL 4064 R	CR HDL 4064 V	
	317,50	22,22				336,55	17,45			
	12.750	0.625	CR HDL 3014 R	CR HDL 3014 V		12.000 304,80	13.500	0.687	CR HDL 4612 R	CR HDL 4612 V
	323,85	15,87					342,90	17,45		
	12.750	0.812	CR HDL 4031 R	CR HDL 4031 V			13.625	0.687	CR HDL 8523 R	CR HDL 8523 V
	323,85	20,62					346,07	17,45		
	13.000	0.812	CR HDL 4022 R	CR HDL 4022 V			13.750	0.687	CR HDL 3701 R	CR HDL 3701 V
	330,20	20,62					349,25	17,45		
	13.250	0.812	CR HDL 4026 R	CR HDL 4026 V			14.000	0.687	CR HDL 5838 R	CR HDL 5838 V
	336,55	20,62					355,60	17,45		
12.375	0.687	CR HDL 4027 R	CR HDL 4027 V	14.000	0.750		CR HDL 4071 R	CR HDL 4071 V		
314,32	17,45			355,60	19,05					
11.000 279,40	12.500	0.687	CR HDL 4028 R	CR HDL 4028 V	12.125 307,97	14.000	0.812	CR HDL 4072 R	CR HDL 4072 V	
	317,50	17,45				355,60	20,62			
	12.250	0.562	CR HDL 3135 R	CR HDL 3135 V		14.750	0.812	CR HDL 3702 R	CR HDL 3702 V	
	311,15	14,28				374,65	20,62			
11.125 282,57	12.500	0.687	CR HDL 4611 R	CR HDL 4611 V	12.250 311,15	13.875	0.687	CR HDL 4053 R	CR HDL 4053 V	
	317,50	17,45				352,42	17,45			
	13.000	0.687	CR HDL 6034 R	CR HDL 6034 V		12.500 317,15	13.750	0.687	CR HDL 4613 R	CR HDL 4613 V
	330,20	17,45					349,25	17,45		
13.000	0.812	CR HDL 4036 R	CR HDL 4036 V	13.750	0.875		CR HDL 4614 R	CR HDL 4614 V		
330,20	20,62			349,25	22,22					
11.125 282,57	13.000	0.687	CR HDL 3699 R	CR HDL 3699 V	12.500 317,15	14.000	0.687	CR HDL 4055 R	CR HDL 4055 V	
	330,20	17,45				355,60	17,45			
	13.250	0.812	CR HDL 3700 R	CR HDL 3700 V		14.250	0.812	CR HDL 4075 R	CR HDL 4075 V	
	336,55	20,62				361,95	20,62			

Type HDL available on request also with dust lip (HDLP Type) and with execution for high pressure (HDLHP Type).

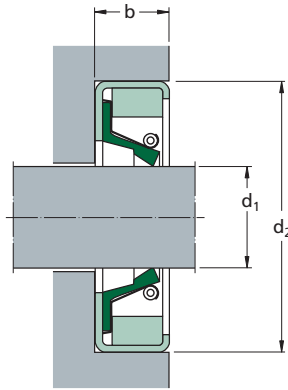

Housing dimensions			Designation		Housing dimensions			Designation		
shaft	bore	width	Lip material	V	shaft	bore	width	Lip material	V	
d ₁	d ₂	b	R		d ₁	d ₂	b	R		
in (mm)			-		in (mm)			-		
12.375 314,32	13.875	0.687	CR HDL 4076 R	CR HDL 4076 V	13.250 336,55	14.750	0.687	CR HDL 4101 R	CR HDL 4101 V	
	352,42	17,45				374,65	17,45			
	14.000	0.687	CR HDL 4056 R	CR HDL 4056 V		14.875	0.687	CR HDL 7734 R	CR HDL 7734 V	
	355,60	17,45				377,82	17,45			
	14.375	0.687	CR HDL 4097 R	CR HDL 4097 V		15.000	0.687	CR HDL 7169 R	CR HDL 7169 V	
	365,12	17,45				381,00	17,45			
12.500 317,50	14.500	0.812	CR HDL 4106 R	CR HDL 4106 V	15.125	0.687	CR HDL 4105 R	CR HDL 4105 V		
	368,30	20,62			384,17	17,45				
	14.000	0.687	CR HDL 4079 R	CR HDL 4079 V	15.250	0.687	CR HDL 6294 R	CR HDL 6294 V		
	355,60	17,45			387,35	17,45				
	14.500	0.750	CR HDL 4082 R	CR HDL 4082 V	15.250	0.812	CR HDL 4779 R	CR HDL 4779 V		
	368,30	19,05			387,35	20,62				
12.625 320,67	14.500	0.812	CR HDL 4083 R	CR HDL 4083 V	13.500 342,90	15.000	0.687	CR HDL 4121 R	CR HDL 4121 V	
	368,30	20,62				381,00	17,45			
	15.000	0.812	CR HDL 4084 R	CR HDL 4084 V		15.500	0.812	CR HDL 4128 R	CR HDL 4128 V	
	381,00	20,62				393,70	20,62			
12.687 322,24	14.125	0.687	CR HDL 4081 R	CR HDL 4081 V	13.625 346,07	15.750	0.812	CR HDL 4123 R	CR HDL 4123 V	
	358,77	17,45				400,05	20,62			
	14.500	0.687	CR HDL 3716 R	CR HDL 3716 V		13.750 349,25	15.500	0.687	CR HDL 4120 R	CR HDL 4120 V
368,30	17,45			393,70	17,45					
14.750	0.812	CR HDL 9766 R	CR HDL 9766 V	15.250	0.687		CR HDL 4529 R	CR HDL 4529 V		
12.750 323,85	374,65	20,62			387,35	17,45				
	14.250	0.687	CR HDL 4089 R	CR HDL 4089 V	15.500	0.750	CR HDL 4531 R	CR HDL 4531 V		
	361,95	17,45			393,70	19,05				
	14.750	0.687	CR HDL 7652 R	CR HDL 7652 V	15.750	0.812	CR HDL 4129 R	CR HDL 4129 V		
	374,65	17,45			400,05	20,62				
12.875 327,02	15.000	0.812	CR HDL 4092 R	CR HDL 4092 V	13.813 350,85	16.000	0.812	CR HDL 4119 R	CR HDL 4119 V	
	381,00	20,62				406,40	20,62			
	15.000	0.812	CR HDL 5404 R	CR HDL 5404 V		13.875 352,42	16.000	0.812	CR HDL 4108 R	CR HDL 4108 V
	381,00	20,62					406,40	20,62		
14.500	0.687	CR HDL 4093 R	CR HDL 4093 V	13.937 353,99	15.437		0.687	CR HDL 4110 R	CR HDL 4110 V	
368,30	17,45				392,09		17,45			
14.875	0.687	CR HDL 4096 R	CR HDL 4096 V		13.938 354,02	15.500	0.687	CR HDL 4130 R	CR HDL 4130 V	
377,82	17,45					393,70	17,45			
15.000	0.812	CR HDL 4099 R	CR HDL 4099 V	13.938 354,02		16.000	0.687	CR HDL 4111 R	CR HDL 4111 V	
381,00	20,62					406,40	17,45			
						16.000	0.687	CR HDL 4112 R	CR HDL 4112 V	
						406,40	17,45			

Type HDL available on request also with dust lip (HDLP Type) and with execution for high pressure (HDLHP Type).

Housing dimensions			Designation		Housing dimensions			Designation	
shaft	bore	width	Lip material	V	shaft	bore	width	Lip material	V
d ₁	d ₂	b	R		d ₁	d ₂	b	R	
in (mm)			–		in (mm)			–	
14.000 355,60	15.500	0.687	CR HDL 4131 R	CR HDL 4131 V	14.875 377,82	16.500	0.687	CR HDL 3858 R	CR HDL 3858 V
	393,70	17,45				419,10	17,45		
	15.750	0.687	CR HDL 5991 R	CR HDL 5991 V		16.750	0.687	CR HDL 3859 R	CR HDL 3859 V
	400,05	17,45				425,45	17,45		
	15.750	0.750	CR HDL 4134 R	CR HDL 4134 V		16.875	0.937	CR HDL 2622 R	CR HDL 2622 V
	400,05	19,05				428,62	23,79		
	16.000	0.812	CR HDL 4135 R	CR HDL 4135 V		16.875	1.000	CR HDL 4150 R	CR HDL 4150 V
	406,40	20,62				428,62	25,40		
	16.250	0.812	CR HDL 5382 R	CR HDL 5382 V		17.000	0.812	CR HDL 3860 R	CR HDL 3860 V
	412,75	20,62				431,80	20,62		
16.500	0.812	CR HDL 7535 R	CR HDL 7535 V	14.906 378,61	17.000	0.812	CR HDL 3861 R	CR HDL 3861 V	
419,10	20,62				431,80	20,62			
14.187 360,34	16.732	0.812	CR HDL 9280 R	CR HDL 9280 V	15.000 381,00	16.500	0.687	CR HDL 4151 R	CR HDL 4151 V
	424,99	20,62				419,10	17,45		
14.250 361,95	15.750	0.687	CR HDL 4118 R	CR HDL 4118 V		17.000	0.812	CR HDL 4156 R	CR HDL 4156 V
	400,05	17,45				431,80	20,62		
	16.000	0.687	CR HDL 4139 R	CR HDL 4139 V		17.250	0.812	CR HDL 3862 R	CR HDL 3862 V
	406,40	17,45				438,15	20,62		
	16.250	0.812	CR HDL 4140 R	CR HDL 4140 V		17.250	0.812	CR HDL 8508 R	CR HDL 8508 V
412,75	20,62			438,15		20,62			
16.500	0.812	CR HDL 3855 R	CR HDL 3855 V	17.500		0.812	CR HDL 9637 R	CR HDL 9637 V	
419,10	20,62			444,50		20,62			
14.375 365,12	16.000	0.687	CR HDL 5481 R	CR HDL 5481 V	17.750	0.812	CR HDL 3862 R	CR HDL 3862 V	
	406,40	17,45			450,85	20,62			
14.500 368,30	16.000	0.687	CR HDL 4142 R	CR HDL 4142 V	15.125 384,17	16.750	0.687	CR HDL 4165 R	CR HDL 4165 V
	406,40	17,45				425,45	17,45		
	16.500	0.812	CR HDL 4145 R	CR HDL 4145 V	15.250 387,35	16.750	0.687	CR HDL 4615 R	CR HDL 4615 V
419,10	20,62			425,45		17,45			
14.625 371,47	16.250	0.687	CR HDL 3856 R	CR HDL 3856 V		17.250	0.812	CR HDL 4476 R	CR HDL 4476 V
	412,75	17,45				438,15	20,62		
	16.750	0.812	CR HDL 3857 R	CR HDL 3857 V		17.250	0.875	CR HDL 3030 R	CR HDL 3030 V
425,45	20,62			438,15	22,22				
14.750 374,65	16.250	0.687	CR HDL 4147 R	CR HDL 4147 V	15.312 388,92	16.875	0.687	CR HDL 4158 R	CR HDL 4158 V
	412,75	17,45				428,62	17,45		
	16.500	0.687	CR HDL 5990 R	CR HDL 5990 V	17.312	0.687	CR HDL 5992 R	CR HDL 5992 V	
	419,10	17,45			439,72	17,45			
15.359 390,11	17.717	0.687	CR HDL 4166 R	CR HDL 4166 V	15.375 390,52	17.717	0.687	CR HDL 4167 R	CR HDL 4167 V
	450,01	17,45				438,15	17,45		
	15.375 390,52	17.250	0.687	CR HDL 4167 R		CR HDL 4167 V	17.375	0.812	CR HDL 4159 R
438,15		17,45				441,32	20,62		
17.375	0.812	CR HDL 4159 R	CR HDL 4159 V						
441,32	20,62								

Type HDL available on request also with dust lip (HDLP Type) and with execution for high pressure (HDLHP Type).

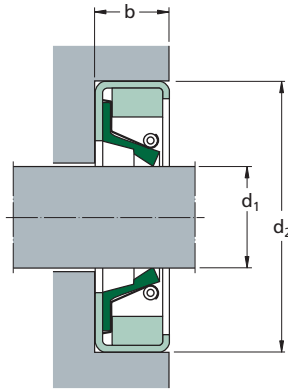

Housing dimensions			Designation		Housing dimensions			Designation						
shaft	bore	width	Lip material	V	shaft	bore	width	Lip material	V					
d ₁	d ₂	b	R		d ₁	d ₂	b	R						
in (mm)			-		in (mm)			-						
15.500 393,70	17.496	0.812	CR HDL 4163 R	CR HDL 4163 V	16.500 419,10	18.000	0.687	CR HDL 9863 R	CR HDL 9863 V					
	444,40	20,62				457,20	17,45							
	17.750	0.812	CR HDL 6771 R	CR HDL 6771 V		18.500	0.687	CR HDL 4187 R	CR HDL 4187 V					
	450,85	20,62				469,90	17,45							
	18.000	0.812	CR HDL 4168 R	CR HDL 4168 V		18.500	0.812	CR HDL 4186 R	CR HDL 4186 V					
457,20	20,62			469,90	20,62			19.000	0.812	CR HDL 4183 R	CR HDL 4183 V			
15.750 400,05	17.165	0.687	CR HDL 9986 R	CR HDL 9986 V	482,60	20,62			16.535 419,98	18.504	0.875	CR HDL 1929 R	CR HDL 1929 V	
	436,00	17,45			470,00	22,22				16.750 425,45	18.250	0.687	CR HDL 3744 R	CR HDL 3744 V
	17.250	0.687	CR HDL 4170 R	CR HDL 4170 V	463,55	17,45			18.500		0.687	CR HDL 8862 R	CR HDL 8862 V	
	438,15	17,45			469,90	17,45			19.000		0.812	CR HDL 3748 R	CR HDL 3748 V	
	17.312	0.687	CR HDL 9271 R	CR HDL 9271 V	482,60	20,62			16.937 430,19		19.291	0.812	CR HDL 9695 R	CR HDL 9695 V
	439,72	17,45			489,99	20,62					17.000 431,80	18.500	0.687	CR HDL 4188 R
	17.500	0.687	CR HDL 4171 R	CR HDL 4171 V	469,90	17,45			19.000			0.812	CR HDL 4190 R	CR HDL 4190 V
	444,50	17,45			482,60	20,62			19.250		0.812	CR HDL 4191 R	CR HDL 4191 V	
	17.750	0.687	CR HDL 6874 R	CR HDL 6874 V	488,95	20,62			19.500		0.812	CR HDL 3750 R	CR HDL 3750 V	
	450,85	17,45			495,30	20,62			17.250 438,15	18.750	0.687	CR HDL 3751 R	CR HDL 3751 V	
18.000	0.812	CR HDL 4172 R	CR HDL 4172 V	476,25	17,45			18.750		0.750	CR HDL 6967 R	CR HDL 6967 V		
457,20	20,62			476,25	19,05			17.500 444,50		19.000	0.687	CR HDL 4194 R	CR HDL 4194 V	
18.500	1.000	CR HDL 4175 R	CR HDL 4175 V	482,60	17,45				19.250	0.687	CR HDL 5054 R	CR HDL 5054 V		
469,90	25,40			488,95	17,45				19.250	1.000	CR HDL 3005 R	CR HDL 3005 V		
15.875 403,22	17.875	0.812	CR HDL 4176 R	CR HDL 4176 V	488,95	25,40				19.500	0.687	CR HDL 4198 R	CR HDL 4198 V	
	454,02	20,62			495,30	17,45				19.750	0.812	CR HDL 4197 R	CR HDL 4197 V	
	16.000 406,40	17.500	0.687	CR HDL 4177 R	CR HDL 4177 V	501,65	20,62							
444,50		17,45												
17.625		0.687	CR HDL 4173 R	CR HDL 4173 V										
447,67	17,45													
18.000	0.812	CR HDL 4180 R	CR HDL 4180 V											
457,20	20,62													
18.000	0.875	CR HDL 5077 R	CR HDL 5077 V											
457,20	22,22													
18.500	0.812	CR HDL 5995 R	CR HDL 5995 V											
469,90	20,62													
16.250 412,75	17.750	0.687	CR HDL 4181 R	CR HDL 4181 V										
	450,85	17,45												
	18.000	0.687	CR HDL 8217 R	CR HDL 8217 V										
	457,20	17,45												
	18.000	0.750	CR HDL 4184 R	CR HDL 4184 V										
	457,20	19,05												
	18.250	0.687	CR HDL 9892 R	CR HDL 9892 V										
463,55	17,45													
18.500	0.812	CR HDL 4174 R	CR HDL 4174 V											
469,90	20,62													
16.375 415,92	17.875	0.687	CR HDL 4179 R	CR HDL 4179 V										
	454,02	17,45												

Type HDL available on request also with dust lip (HDLP Type) and with execution for high pressure (HDLHP Type).

Housing dimensions			Designation		Housing dimensions			Designation	
shaft	bore	width	Lip material	V	shaft	bore	width	Lip material	V
d ₁	d ₂	b	R		d ₁	d ₂	b	R	
in (mm)			–		in (mm)			–	
17.625 447,67	19.250 488,95	0.687 17,45	CR HDL 4199 R	CR HDL 4199 V	18.500 469,90	20.000 508,00	0.687 17,45	CR HDL 3768 R	CR HDL 3768 V
	19.625 498,47	0.687 17,45	CR HDL 6850 R	CR HDL 6850 V		20.250 514,35	0.687 17,45	CR HDL 3772 R	CR HDL 3772 V
						20.500 520,70	0.875 22,22	CR HDL 4216 R	CR HDL 4216 V
17.750 450,85	19.750 501,65	0.812 20,62	CR HDL 4200 R	CR HDL 4200 V					
	20.078 509,98	0.875 22,22	CR HDL 9084 R	CR HDL 9084 V	19.000 482,60	20.500 520,70	0.750 19,05	CR HDL 4218 R	CR HDL 4218 V
						21.000 533,40	0.875 22,22	CR HDL 4219 R	CR HDL 4219 V
17.875 454,02	19.875 504,82	0.812 20,62	CR HDL 4204 R	CR HDL 4204 V		21.500 546,10	0.875 22,22	CR HDL 3773 R	CR HDL 3773 V
18.000 457,20	19.500 495,30	0.687 17,45	CR HDL 4206 R	CR HDL 4206 V	19.250 488,95	20.750 527,05	0.750 19,05	CR HDL 4617 R	CR HDL 4617 V
	19.750 501,65	0.687 17,45	CR HDL 5728 R	CR HDL 5728 V		21.000 533,40	0.750 19,05	CR HDL 3777 R	CR HDL 3777 V
	19.875 504,82	0.687 17,45	CR HDL 4203 R	CR HDL 4203 V		21.250 539,75	0.750 19,05	CR HDL 5485 R	CR HDL 5485 V
	20.000 508,00	0.750 19,05	CR HDL 4209 R	CR HDL 4209 V					
	20.000 508,00	0.875 22,22	CR HDL 4210 R	CR HDL 4210 V	19.375 492,12	21.000 533,40	0.750 19,05	CR HDL 3778 R	CR HDL 3778 V
	20.500 520,70	0.875 22,22	CR HDL 3752 R	CR HDL 3752 V					
	21.000 533,40	0.875 22,22	CR HDL 3753 R	CR HDL 3753 V	19.500 495,30	21.000 533,40	0.750 19,05	CR HDL 3779 R	CR HDL 3779 V
						21.500 546,10	0.875 22,22	CR HDL 4221 R	CR HDL 4221 V
18.120 460,24	20.500 520,70	0.875 22,22	CR HDL 3754 R	CR HDL 3754 V		21.688 550,87	0.875 22,22	CR HDL 3783 R	CR HDL 3783 V
18.125 460,37	20.500 520,70	0.875 22,22	CR HDL 3756 R	CR HDL 3756 V	19.750 501,65	21.750 552,45	0.875 22,22	CR HDL 4228 R	CR HDL 4228 V
						22.125 561,97	0.875 22,22	CR HDL 7400 R	CR HDL 7400 V
18.250 463,55	19.750 501,65	0.687 17,45	CR HDL 3757 R	CR HDL 3757 V		22.250 565,15	0.875 22,22	CR HDL 3785 R	CR HDL 3785 V
	19.875 504,82	0.687 17,45	CR HDL 3765 R	CR HDL 3765 V					
					19.875 504,82	22.000 558,80	0.875 22,22	CR HDL 3788 R	CR HDL 3788 V
18.375 466,72	19.875 504,82	0.687 17,45	CR HDL 4213 R	CR HDL 4213 V					
	19.937 506,39	0.687 17,45	CR HDL 7103 R	CR HDL 7103 V	19.937 506,39	21.687 550,84	0.625 15,87	CR HDL 4233 R	CR HDL 4233 V
	20.000 508,00	0.750 19,05	CR HDL 4215 R	CR HDL 4215 V					
	20.375 517,52	0.812 20,62	CR HDL 6740 R	CR HDL 6740 V	19.938 506,42	21.500 546,10	0.750 19,05	CR HDL 3789 R	CR HDL 3789 V
	20.500 520,70	0.750 19,05	CR HDL 3767 R	CR HDL 3767 V					

Type HDL available on request also with dust lip (HDLP Type) and with execution for high pressure (HDLHP Type).

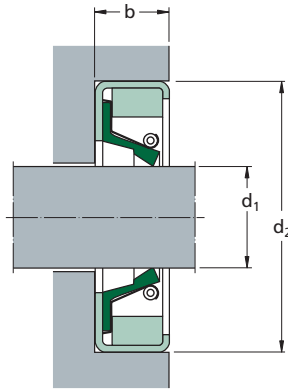

Housing dimensions			Designation		Housing dimensions			Designation		
shaft	bore	width	Lip material	V	shaft	bore	width	Lip material	V	
d ₁	d ₂	b	R		d ₁	d ₂	b	R		
in (mm)			-		in (mm)			-		
20.000 508,00	21.500	0.750	CR HDL 4235 R	CR HDL 4235 V	21.000 533,40	22.500	0.750	CR HDL 5259 R	CR HDL 5259 V	
	546,10	19,05				571,50	19,05			
	21.750	0.750	CR HDL 4236 R	CR HDL 4236 V		22.750	0.750	CR HDL 5312 R	CR HDL 5312 V	
	552,45	19,05				577,85	19,05			
	22.000	0.875	CR HDL 4237 R	CR HDL 4237 V		23.000	0.812	CR HDL 6535 R	CR HDL 6535 V	
	558,80	22,22				584,20	20,62			
20.143 511,63	22.500	0.875	CR HDL 3790 R	CR HDL 3790 V	23.000	0.875	CR HDL 4253 R	CR HDL 4253 V		
	571,50	22,22			584,20	22,22				
	22.250	0.875	CR HDL 3792 R	CR HDL 3792 V	23.250	0.812	CR HDL 4251 R	CR HDL 4251 V		
	565,15	22,22			590,55	20,62				
	20.250	0.875	CR HDL 4239 R	CR HDL 4239 V	23.500	0.875	CR HDL 9772 R	CR HDL 9772 V		
	514,35	19,05			596,90	22,22				
20.438 519,12	22.245	0.875	CR HDL 8231 R	CR HDL 8231 V	21.250 539,75	23.000	0.750	CR HDL 4255 R	CR HDL 4255 V	
	565,02	22,22				584,20	19,05			
	22.250	0.875	CR HDL 4240 R	CR HDL 4240 V		23.250	0.875	CR HDL 4254 R	CR HDL 4254 V	
	565,15	22,22				590,55	22,22			
	22.375	0.750	CR HDL 4241 R	CR HDL 4241 V		21.437	23.187	0.750	CR HDL 4256 R	CR HDL 4256 V
	568,32	19,05				544,49	588,94	19,05		
20.500 520,70	22.500	0.875	CR HDL 8770 R	CR HDL 8770 V	21.500 546,10	23.250	0.750	CR HDL 4257 R	CR HDL 4257 V	
	571,50	22,22				590,55	19,05			
	22.500	0.812	CR HDL 4242 R	CR HDL 4242 V		23.500	0.812	CR HDL 7407 R	CR HDL 7407 V	
	571,50	20,62				596,90	20,62			
	22.000	0.750	CR HDL 4619 R	CR HDL 4619 V		23.500	0.875	CR HDL 4259 R	CR HDL 4259 V	
	558,80	19,05				596,90	22,22			
20.625 523,87	22.250	0.812	CR HDL 4245 R	CR HDL 4245 V	21.625 549,27	23.625	0.875	CR HDL 6493 R	CR HDL 6493 V	
	565,15	20,62				600,07	22,22			
	22.500	0.875	CR HDL 4246 R	CR HDL 4246 V		24.000	0.875	CR HDL 6779 R	CR HDL 6779 V	
	571,50	22,22				609,60	22,22			
	22.750	0.875	CR HDL 6287 R	CR HDL 6287 V		21.625	23.375	0.750	CR HDL 4261 R	CR HDL 4261 V
	577,85	22,22				549,27	593,72	19,05		
20.750 527,05	22.625	0.812	CR HDL 9893 R	CR HDL 9893 V	21.750 552,45	23.625	0.875	CR HDL 4263 R	CR HDL 4263 V	
	574,67	20,62				600,07	22,22			
	22.750	0.875	CR HDL 4248 R	CR HDL 4248 V		21.750	23.250	0.750	CR HDL 4621 R	CR HDL 4621 V
	577,85	22,22				552,45	590,55	19,05		
	23.000	0.812	CR HDL 4243 R	CR HDL 4243 V		23.750	0.875	CR HDL 4265 R	CR HDL 4265 V	
	584,20	20,62				603,25	22,22			
20.875 530,22	24.000	0.875	CR HDL 6779 R	CR HDL 6779 V	20.875 530,22	24.000	0.875	CR HDL 5276 R	CR HDL 5276 V	
	571,50	22,22				609,60	22,22			
	22.875	0.875	CR HDL 4250 R	CR HDL 4250 V		24.250	0.875	CR HDL 8675 R	CR HDL 8675 V	
	581,02	22,22				615,95	22,22			
	23.228	0.875	CR HDL 6417 R	CR HDL 6417 V		24.500	0.875	CR HDL 4260 R	CR HDL 4260 V	
	589,99	22,22				622,30	22,22			
					24.750	0.875	CR HDL 4262 R	CR HDL 4262 V		
					628,65	22,22				

Type HDL available on request also with dust lip (HDLP Type) and with execution for high pressure (HDLHP Type).

Housing dimensions			Designation		Housing dimensions			Designation		
shaft	bore	width	Lip material	V	shaft	bore	width	Lip material	V	
d ₁	d ₂	b	R		d ₁	d ₂	b	R		
in (mm)			–		in (mm)			–		
22.000 558,80	23.500	0.750	CR HDL 4269 R	CR HDL 4269 V	23.000 584,20	24.500	0.750	CR HDL 4283 R	CR HDL 4283 V	
	596,90	19,05				622,30	19,05			
	24.000	0.875	CR HDL 4270 R	CR HDL 4270 V		24.750	0.750	CR HDL 5421 R	CR HDL 5421 V	
	609,60	22,22				628,65	19,05			
	24.250	0.812	CR HDL 9082 R	CR HDL 9082 V		25.000	0.875	CR HDL 4284 R	CR HDL 4284 V	
	615,95	20,62				635,00	22,22			
	24.250	0.875	CR HDL 3763 R	CR HDL 3763 V		25.375	0.875	CR HDL 4277 R	CR HDL 4277 V	
615,95	22,22			644,52	22,22					
24.500	0.875	CR HDL 6295 R	CR HDL 6295 V	25.500	0.875	CR HDL 4285 R	CR HDL 4285 V			
622,30	22,22			647,70	22,22					
22.250 565,15	24.250	0.875	CR HDL 3764 R	CR HDL 3764 V	23.250 590,55	25.000	0.750	CR HDL 4286 R	CR HDL 4286 V	
	615,95	22,22				635,00	19,05			
22.375 568,32	24.250	0.750	CR HDL 4268 R	CR HDL 4268 V	23.375 593,72	25.250	0.750	CR HDL 9371 R	CR HDL 9371 V	
	615,95	19,05				641,35	19,05			
	24.375	0.750	CR HDL 6999 R	CR HDL 6999 V		25.250	0.812	CR HDL 6910 R	CR HDL 6910 V	
	619,12	19,05				641,35	20,62			
24.375	0.875	CR HDL 2576 R	CR HDL 2576 V	25.375	0.875	CR HDL 4287 R	CR HDL 4287 V			
619,12	22,22			593,72	644,52	22,22				
22.437 569,89	24.000	0.750	CR HDL 4275 R	CR HDL 4275 V	23.500 596,90	24.681	0.591	CR HDL 3033 R	CR HDL 3033 V	
	609,60	19,05				626,90	15,00			
	24.250	0.750	CR HDL 4276 R	CR HDL 4276 V		25.250	0.750	CR HDL 5547 R	CR HDL 5547 V	
	615,95	19,05				641,35	19,05			
	24.437	0.750	CR HDL 6480 R	CR HDL 6480 V		25.500	0.875	CR HDL 4288 R	CR HDL 4288 V	
	620,69	19,05				647,70	22,22			
	24.437	0.875	CR HDL 1915 R	CR HDL 1915 V		23.562	25.250	0.750	CR HDL 4290 R	CR HDL 4290 V
620,69	22,22			598,47	641,35	19,05				
24.500	0.750	CR HDL 9840 R	CR HDL 9840 V	25.375	0.750	CR HDL 4291 R	CR HDL 4291 V			
622,30	19,05			644,52	19,05					
22.500 571,50	24.000	0.750	CR HDL 4271 R	CR HDL 4271 V	23.625 600,07	26.000	0.875	CR HDL 4292 R	CR HDL 4292 V	
	609,60	19,05				660,40	22,22			
	24.250	0.750	CR HDL 4272 R	CR HDL 4272 V		23.750	25.250	1.000	CR HDL 6239 R	CR HDL 6239 V
	615,95	19,05				603,25	641,35	25,40		
	24.500	0.875	CR HDL 4279 R	CR HDL 4279 V		23.875	26.000	0.875	CR HDL 4293 R	CR HDL 4293 V
	622,30	22,22				606,42	660,40	22,22		
	24.750	0.875	CR HDL 4273 R	CR HDL 4273 V						
628,65	22,22									
25.000	0.875	CR HDL 4274 R	CR HDL 4274 V							
635,00	22,22									
22.750 577,85	24.750	0.875	CR HDL 4281 R	CR HDL 4281 V						
	628,65	22,22								
	25.000	0.875	CR HDL 6843 R	CR HDL 6843 V						
635,00	22,22									

Type HDL available on request also with dust lip (HDLP Type) and with execution for high pressure (HDLHP Type).

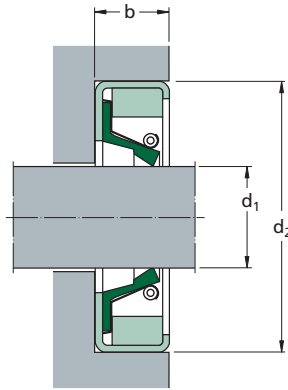

Housing dimensions			Designation		Housing dimensions			Designation		
shaft	bore	width	Lip material	V	shaft	bore	width	Lip material	V	
d_1	d_2	b	R		d_1	d_2	b	R		
in (mm)			-		in (mm)			-		
24.000 609,60	25.500	0.750	CR HDL 4623 R	CR HDL 4623 V	25.500 647,70	26.750	0.750	CR HDL 3022 R	CR HDL 3022 V	
	647,70	19,05				679,45	19,05			
	26.000	0.750	CR HDL 9988 R	CR HDL 9988 V		27.000	0.875	CR HDL 4300 R	CR HDL 4300 V	
	660,40	19,05				685,80	22,22			
	26.000	0.812	CR HDL 4295 R	CR HDL 4295 V		27.500	0.875	CR HDL 4318 R	CR HDL 4318 V	
	660,40	20,62				698,50	22,22			
	26.000	0.875	CR HDL 4294 R	CR HDL 4294 V		25.750 654,05	27.500	0.750	CR HDL 6998 R	CR HDL 6998 V
	660,40	22,22					698,50	19,05		
	26.250	0.875	CR HDL 6293 R	CR HDL 6293 V		25.875 657,22	28.000	0.875	CR HDL 4303 R	CR HDL 4303 V
	666,75	22,22					711,20	22,22		
26.500	0.875	CR HDL 4297 R	CR HDL 4297 V	25.988 660,09	27.625	0.750	CR HDL 4306 R	CR HDL 4306 V		
673,10	22,22				701,67	19,05				
27.000	0.875	CR HDL 5644 R	CR HDL 5644 V	26.000 660,40	27.625	0.750	CR HDL 5921 R	CR HDL 5921 V		
685,80	22,22				701,67	19,05				
24.250 615,95	26.250	0.875	CR HDL 4301 R	CR HDL 4301 V	26.000 660,40	28.000	0.875	CR HDL 4325 R	CR HDL 4325 V	
	666,75	22,22				711,20	22,22			
	26.250	1.000	CR HDL 3770 R	CR HDL 3770 V		28.125	0.875	CR HDL 9402 R	CR HDL 9402 V	
24.437 620,69	660,40	0.750	CR HDL 4302 R	CR HDL 4302 V	26.125 663,57	714,37	22,22			
	26.437	0.750	CR HDL 4304 R	CR HDL 4304 V		28.500	0.875	CR HDL 4794 R	CR HDL 4794 V	
	671,49	19,05				723,90	22,22			
	26.935	1.000	CR HDL 9990 R	CR HDL 9990 V		27.625	0.750	CR HDL 4329 R	CR HDL 4329 V	
684,15	25,40			701,67	19,05					
24.500 622,30	26.500	0.875	CR HDL 4305 R	CR HDL 4305 V	26.375 669,92	28.125	0.875	CR HDL 4330 R	CR HDL 4330 V	
	673,10	22,22				714,37	22,22			
25.000 635,00	26.500	0.750	CR HDL 4308 R	CR HDL 4308 V	26.500 673,10	28.188	0.875	CR HDL 4307 R	CR HDL 4307 V	
	673,10	19,05				715,97	22,22			
	27.000	0.875	CR HDL 3774 R	CR HDL 3774 V		28.250	0.875	CR HDL 4312 R	CR HDL 4312 V	
	685,80	22,22				717,55	22,22			
	27.000	1.000	CR HDL 4309 R	CR HDL 4309 V		27.000 685,80	28.000	0.750	CR HDL 4533 R	CR HDL 4533 V
	685,80	25,40					711,20	19,05		
27.250	0.875	CR HDL 6421 R	CR HDL 6421 V	27.000 685,80	28.500	0.875	CR HDL 4313 R	CR HDL 4313 V		
692,15	22,22				723,90	22,22				
27.482	0.875	CR HDL 5997 R	CR HDL 5997 V	27.000 685,80	29.000	0.875	CR HDL 4333 R	CR HDL 4333 V		
698,05	22,22				736,60	22,22				
25.187 639,74	26.875	0.750	CR HDL 4311 R		CR HDL 4311 V	29.500	0.875	CR HDL 8031 R	CR HDL 8031 V	
	682,62	19,05					749,30	22,22		
	26.937	0.750	CR HDL 5994 R	CR HDL 5994 V	30.000		0.875	CR HDL 9984 R	CR HDL 9984 V	
684,19	19,05			762,00	22,22					
25.250 641,35	27.250	0.750	CR HDL 4299 R	CR HDL 4299 V	27.250 692,15	29.250	0.875	CR HDL 4626 R	CR HDL 4626 V	
	692,15	19,05				742,95	22,22			

Type HDL available on request also with dust lip (HDL P Type) and with execution for high pressure (HDLHP Type).

Housing dimensions			Designation		Housing dimensions			Designation	
shaft	bore	width	Lip material	V	shaft	bore	width	Lip material	V
d ₁	d ₂	b	R		d ₁	d ₂	b	R	
in (mm)			–		in (mm)			–	
27.500 698,50	29.000	0.750	CR HDL 4315 R	CR HDL 4315 V	29.500 749,30	31.500	0.875	CR HDL 4352 R	CR HDL 4352 V
	736,60	19,05				800,10	22,22		
	29.500	0.875	CR HDL 4339 R	CR HDL 4339 V		31.500	1.000	CR HDL 3791 R	CR HDL 3791 V
	749,30	22,22			800,10	25,40			
27.625 701,67	29.625	0.750	CR HDL 5001 R	CR HDL 5001 V		32.000	0.875	CR HDL 4538 R	CR HDL 4538 V
	752,47	19,05				812,80	22,22		
	29.500	0.750	CR HDL 4336 R	CR HDL 4336 V		32.250	0.875	CR HDL 4322 R	CR HDL 4322 V
	749,30	19,05				819,15	22,22		
27.875 708,02	29.812	0.875	CR HDL 4341 R	CR HDL 4341 V	30.000 762,00	31.500	0.750	CR HDL 4356 R	CR HDL 4356 V
	757,22	22,22				800,10	19,05		
28.000 711,20	29.500	0.750	CR HDL 4343 R	CR HDL 4343 V		31.616	0.750	CR HDL 5000 R	CR HDL 5000 V
	749,30	19,05				803,04	19,05		
	29.625	0.750	CR HDL 7828 R	CR HDL 7828 V		31.625	0.750	CR HDL 7870 R	CR HDL 7870 V
	752,47	19,05				803,27	19,05		
	29.813	0.750	CR HDL 4316 R	CR HDL 4316 V		32.000	0.875	CR HDL 4357 R	CR HDL 4357 V
	757,25	19,05				812,80	22,22		
	30.000	0.875	CR HDL 4344 R	CR HDL 4344 V		32.250	0.875	CR HDL 4323 R	CR HDL 4323 V
	762,00	22,22				819,15	22,22		
	30.250	0.812	CR HDL 4320 R	CR HDL 4320 V		32.500	0.875	CR HDL 4358 R	CR HDL 4358 V
	768,35	20,62				825,50	22,22		
	30.500	0.875	CR HDL 3878 R	CR HDL 3878 V		32.500	1.000	CR HDL 3797 R	CR HDL 3797 V
	774,70	22,22				825,50	25,40		
	31.000	0.875	CR HDL 5998 R	CR HDL 5998 V		32.750	0.875	CR HDL 4359 R	CR HDL 4359 V
	787,40	22,22				831,85	22,22		
28.438 722,32	31.000	0.875	CR HDL 4321 R	CR HDL 4321 V	30.250 768,35	33.000	0.875	CR HDL 4360 R	CR HDL 4360 V
	787,40	22,22				838,20	22,22		
28.500 723,90	30.500	0.875	CR HDL 4346 R	CR HDL 4346 V	30.312 769,92	32.500	0.875	CR HDL 4906 R	CR HDL 4906 V
	774,70	22,22				825,50	22,22		
	31.000	0.875	CR HDL 4534 R	CR HDL 4534 V			32.375	0.875	CR HDL 4361 R
	787,40	22,22				822,32	22,22		
28.750 730,25	30.750	0.875	CR HDL 4628 R	CR HDL 4628 V	30.500 774,70	32.500	0.875	CR HDL 4365 R	CR HDL 4365 V
	781,05	22,22				825,50	22,22		
29.000 736,60	30.500	0.750	CR HDL 4347 R	CR HDL 4347 V		33.000	0.875	CR HDL 8577 R	CR HDL 8577 V
	774,70	19,05				838,20	22,22		
	31.000	0.875	CR HDL 4348 R	CR HDL 4348 V		33.500	0.875	CR HDL 8230 R	CR HDL 8230 V
	787,40	22,22				850,90	22,22		
	31.500	1.000	CR HDL 8793 R	CR HDL 8793 V					
800,10	25,40								
32.000	0.875	CR HDL 4537 R	CR HDL 4537 V						
812,80	22,22								

Type HDL available on request also with dust lip (HDLP Type) and with execution for high pressure (HDLHP Type).

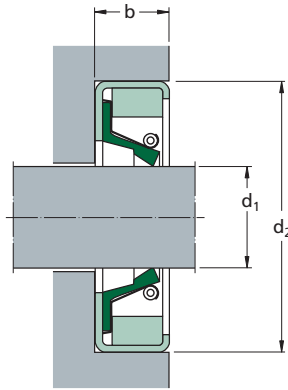

Housing dimensions			Designation	
shaft	bore	width	Lip material	V
d ₁	d ₂	b	R	
in (mm)			-	
31.000 787,40	32.500	0.750	CR HDL 5739 R	CR HDL 5739 V
	825,50	19,05		
	33.000	0.875	CR HDL 4367 R	CR HDL 4367 V
	838,20	22,22		
	33.500	0.875	CR HDL 4540 R	CR HDL 4540 V
	850,90	22,22		
31.250 793,75	32.750	0.750	CR HDL 4631 R	CR HDL 4631 V
	831,85	19,05		
	33.250	0.750	CR HDL 5033 R	CR HDL 5033 V
	844,55	19,05		
31.750 806,45	33.750	0.875	CR HDL 5016 R	CR HDL 5016 V
	857,25	22,22		
32.000 812,80	33.500	0.750	CR HDL 3023 R	CR HDL 3023 V
	850,90	19,05		
	34.000	0.875	CR HDL 4632 R	CR HDL 4632 V
	863,60	22,22		
32.125 815,97	34.500	0.875	CR HDL 8407 R	CR HDL 8407 V
	876,30	22,22		
	34.125	0.875	CR HDL 4371 R	CR HDL 4371 V
	866,77	22,22		
32.312 820,72	34.625	0.875	CR HDL 7537 R	CR HDL 7537 V
	879,47	22,22		
	34.125	0.750	CR HDL 3002 R	CR HDL 3002 V
	866,77	19,05		
32.500 825,50	34.500	0.875	CR HDL 4373 R	CR HDL 4373 V
	876,30	22,22		
32.750 831,85	34.500	0.875	CR HDL 4377 R	CR HDL 4377 V
	825,50	22,22		
	34.250	0.750	CR HDL 4542 R	CR HDL 4542 V
	869,95	19,05		
32.875 838,20	35.000	0.875	CR HDL 8289 R	CR HDL 8289 V
	889,00	22,22		
	33.000	0.875	CR HDL 4381 R	CR HDL 4381 V

Housing dimensions			Designation	
shaft	bore	width	Lip material	V
d ₁	d ₂	b	R	
in (mm)			-	
33.000 838,20	34.500	0.750	CR HDL 4381 R	CR HDL 4381 V
	876,30	19,05		
	34.625	0.750	CR HDL 6787 R	CR HDL 6787 V
	879,47	19,05		
	34.650	0.787	CR HDL 4634 R	CR HDL 4634 V
	880,10	20,00		
	34.687	0.750	CR HDL 6152 R	CR HDL 6152 V
	881,04	19,05		
	35.000	0.875	CR HDL 4382 R	CR HDL 4382 V
	889,00	22,22		
	35.250	0.875	CR HDL 4326 R	CR HDL 4326 V
33.500 850,90	895,35	22,22		
	35.500	0.875	CR HDL 4544 R	CR HDL 4544 V
	901,70	22,22		
	35.000	0.875	CR HDL 9504 R	CR HDL 9504 V
	889,00	22,22		
	35.500	0.875	CR HDL 4389 R	CR HDL 4389 V
	901,70	22,22		
	35.625	0.875	CR HDL 4548 R	CR HDL 4548 V
	904,87	22,22		
	35.625	0.875	CR HDL 4327 R	CR HDL 4327 V
	904,87	22,22		
35.750	0.875	CR HDL 4549 R	CR HDL 4549 V	
908,05	22,22			
36.000	0.875	CR HDL 4550 R	CR HDL 4550 V	
914,40	22,22			
36.417	0.875	CR HDL 4552 R	CR HDL 4552 V	
924,99	22,22			
33.625 854,07	35.625	0.875	CR HDL 4328 R	CR HDL 4328 V
	904,87	22,22		
34.000 863,60	35.625	0.875	CR HDL 4331 R	CR HDL 4331 V
	904,87	22,22		
	36.000	0.875	CR HDL 4399 R	CR HDL 4399 V
	914,40	22,22		
	36.500	0.875	CR HDL 4400 R	CR HDL 4400 V
	927,10	22,22		
37.000	0.875	CR HDL 4332 R	CR HDL 4332 V	
939,80	22,22			

Type HDL available on request also with dust lip (HDLP Type) and with execution for high pressure (HDLHP Type).

Housing dimensions			Designation		Housing dimensions			Designation		
shaft	bore	width	Lip material	V	shaft	bore	width	Lip material	V	
d ₁	d ₂	b	R		d ₁	d ₂	b	R		
in (mm)			–		in (mm)			–		
34.250 869,95	36.000	0.750	CR HDL 3017 R	CR HDL 3017 V	36.000 914,40	38.000	0.875	CR HDL 4421 R	CR HDL 4421 V	
	914,40	19,05				965,20	22,22			
	36.250	0.875	CR HDL 4401 R	CR HDL 4401 V		38.500	1.000	CR HDL 9993 R	CR HDL 9993 V	
	920,75	22,22				977,90	25,40			
	36.750	0.875	CR HDL 4335 R	CR HDL 4335 V						
34.500 876,30	933,45	22,22			36.500 927,10	38.000	0.750	CR HDL 4429 R	CR HDL 4429 V	
	37.500	0.875	CR HDL 4338 R	CR HDL 4338 V		965,20	19,05			
	952,50	22,22				38.500	0.875	CR HDL 4430 R	CR HDL 4430 V	
	36.000	0.750	CR HDL 6908 R	CR HDL 6908 V		977,90	22,22			
	914,40	19,05								
34.750 882,65	36.500	0.875	CR HDL 4405 R	CR HDL 4405 V	36.750 933,45	38.750	0.875	CR HDL 4432 R	CR HDL 4432 V	
	927,10	22,22				984,25	22,22			
	36.500	1.000	CR HDL 3021 R	CR HDL 3021 V		39.250	0.875	CR HDL 7428 R	CR HDL 7428 V	
	927,10	25,40				996,95	22,22			
	37.500	0.875	CR HDL 4338 R	CR HDL 4338 V						
35.000 889,00	952,50	22,22			37.000 939,80	39.000	0.875	CR HDL 4434 R	CR HDL 4434 V	
	36.750	0.875	CR HDL 3831 R	CR HDL 3831 V		990,60	22,22			
	933,45	22,22				37.250 946,15	39.250	0.875	CR HDL 4436 R	CR HDL 4436 V
	37.000	0.875	CR HDL 3835 R	CR HDL 3835 V			996,95	22,22		
	939,80	22,22					37.374 949,30	39.500	0.875	CR HDL 4425 R
37.500	0.875	CR HDL 3836 R	CR HDL 3836 V	1 003,30	22,22					
952,50	22,22			37.437 950,89	39.500			0.875	CR HDL 3847 R	CR HDL 3847 V
38.000	0.875	CR HDL 3837 R	CR HDL 3837 V		1 003,30	22,22				
965,20	22,22									
35.250 895,35	37.250	0.875	CR HDL 4416 R		CR HDL 4416 V	37.500 952,50	39.000	0.750	CR HDL 9411 R	CR HDL 9411 V
	946,15	22,22					990,60	19,05		
	38.250	0.812	CR HDL 4647 R	CR HDL 4647 V	39.500		0.875	CR HDL 4438 R	CR HDL 4438 V	
35.375 898,52	971,55	20,62			38.000 965,20	1 003,30	22,22			
	37.375	0.875	CR HDL 4417 R	CR HDL 4417 V		39.500	0.750	CR HDL 3004 R	CR HDL 3004 V	
	949,32	22,22				1 003,30	19,05			
35.437 900,09	38.583	0.875	CR HDL 9079 R	CR HDL 9079 V	38.250 971,55	40.000	0.875	CR HDL 4448 R	CR HDL 4448 V	
	980,00	22,22				1 016,00	22,22			
	37.996	0.984	CR HDL 3001 R	CR HDL 3001 V		41.000	0.875	CR HDL 4340 R	CR HDL 4340 V	
35.496 901,60	965,10	25,00			38.250 971,55	1 041,40	22,22			
	37.500	0.875	CR HDL 4553 R	CR HDL 4553 V		40.250	0.875	CR HDL 4454 R	CR HDL 4454 V	
	952,50	22,22				1 022,35	22,22			
35.500 901,70	37.500	0.875	CR HDL 4553 R	CR HDL 4553 V	38.250 971,55	40.750	0.875	CR HDL 4567 R	CR HDL 4567 V	
	952,50	22,22				1 035,05	22,22			
	38.077	0.687	CR HDL 3003 R	CR HDL 3003 V		41.250	0.875	CR HDL 4569 R	CR HDL 4569 V	
35.827 910,00	967,15	17,45			38.258 971,75	1 047,75	22,22			
	38.077	0.687	CR HDL 3003 R	CR HDL 3003 V		40.750	0.875	CR HDL 4342 R	CR HDL 4342 V	
	967,15	17,45				1 035,05	22,22			

Type HDL available on request also with dust lip (HDLP Type) and with execution for high pressure (HDLHP Type).

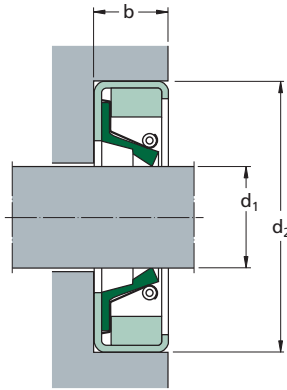

Housing dimensions			Designation		Housing dimensions			Designation	
shaft	bore	width	Lip material	V	shaft	bore	width	Lip material	V
d ₁	d ₂	b	R		d ₁	d ₂	b	R	
in (mm)			-		in (mm)			-	
38.500 977,90	41.000 1 041,40	0.875 22,22	CR HDL 4349 R	CR HDL 4349 V	42.500 1 079,50	44.250 1 123,95	0.875 22,22	CR HDL 5555 R	CR HDL 5555 V
						45.000 1 143,00	0.875 22,22	CR HDL 4473 R	CR HDL 4473 V
38.750 984,25	40.750 1 035,05	0.875 22,22	CR HDL 4456 R	CR HDL 4456 V		45.500 1 155,70	0.875 22,22	CR HDL 6269 R	CR HDL 6269 V
	41.000 1 041,40	0.875 22,22	CR HDL 4570 R	CR HDL 4570 V					
38.937 988,99	41.000 1 041,40	0.875 22,22	CR HDL 4462 R	CR HDL 4462 V	43.000 1 092,20	45.500 1 155,70	0.875 22,22	CR HDL 7189 R	CR HDL 7189 V
						45.500 1 155,70	1.000 25,40	CR HDL 9994 R	CR HDL 9994 V
39.000 990,60	41.000 1 041,40	0.875 22,22	CR HDL 4465 R	CR HDL 4465 V	43.500 1 104,90	45.500 1 155,70	0.875 22,22	CR HDL 4637 R	CR HDL 4637 V
	41.500 1 054,10	0.875 22,22	CR HDL 4350 R	CR HDL 4350 V	43.750 1 111,25	45.750 1 162,05	0.875 22,22	CR HDL 4638 R	CR HDL 4638 V
	42.250 1 073,15	0.875 22,22	CR HDL 4577 R	CR HDL 4577 V	44.000 1 117,60	46.000 1 168,40	0.875 22,22	CR HDL 7087 R	CR HDL 7087 V
39.750 1 009,65	42.250 1 073,15	0.875 22,22	CR HDL 7538 R	CR HDL 7538 V		46.500 1 181,10	0.875 22,22	CR HDL 4475 R	CR HDL 4475 V
						46.500 1 181,10	1.000 25,40	CR HDL 3024 R	CR HDL 3024 V
40.000 1 016,00	42.000 1 066,80	0.875 22,22	CR HDL 4467 R	CR HDL 4467 V	44.500 1 130,30	46.000 1 168,40	0.750 19,05	CR HDL 4563 R	CR HDL 4563 V
	42.500 1 079,50	0.875 22,22	CR HDL 8791 R	CR HDL 8791 V		46.625 1 184,27	1.000 25,40	CR HDL 8903 R	CR HDL 8903 V
	42.500 1 079,50	1.000 25,40	CR HDL 8599 R	CR HDL 8599 V					
40.500 1 028,70	42.500 1 079,50	0.875 22,22	CR HDL 4468 R	CR HDL 4468 V	46.004 1 168,50	47.500 1 206,50	0.750 19,05	CR HDL 3006 R	CR HDL 3006 V
	43.000 1 092,20	0.875 22,22	CR HDL 7300 R	CR HDL 7300 V	46.500 1 181,10	48.500 1 231,90	0.875 22,22	CR HDL 4578 R	CR HDL 4578 V
	43.020 1 092,70	0.875 22,22	CR HDL 1964 R	CR HDL 1964 V	46.850 1 189,99	48.819 1 240,00	0.875 22,22	CR HDL 8317 R	CR HDL 8317 V
41.500 1 054,10	43.500 1 104,90	0.875 22,22	CR HDL 4635 R	CR HDL 4635 V	48.000 1 219,20	50.000 1 270,00	0.875 22,22	CR HDL 8579 R	CR HDL 8579 V
41.875 1 063,62	43.500 1 104,90	1.000 25,40	CR HDL 8628 R	CR HDL 8628 V	48.250 1 225,55	50.250 1 276,35	0.875 22,22	CR HDL 4639 R	CR HDL 4639 V
42.248 1 073,10	44.248 1 123,90	1.000 25,40	CR HDL 4470 R	CR HDL 4470 V					
					51.248 1 301,71	53.289 1 353,55	0.875 22,22	CR HDL 6747 R	CR HDL 6747 V
					51.250 1 301,75	53.300 1 353,82	0.875 22,22	CR HDL 1914 R	CR HDL 1914 V

Type HDL available on request also with dust lip (HDLP Type) and with execution for high pressure (HDLHP Type).



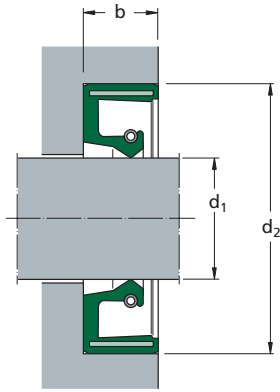

Housing dimensions			Lip material	Designation	Housing dimensions			Lip material	Designation
shaft	bore	width			shaft	bore	width		
d ₁	d ₂	b							
mm			–		mm			–	
175	205	15	R V	CR 175×205×15 SBF R CR 175×205×15 SBF V	400	440	20	R V	CR 400×440×20 SBF R CR 400×440×20 SBF V
230	260	15	R V	CR 230×260×15 SBF R CR 230×260×15 SBF V	430	480	22	R V	CR 430×480×22 SBF R CR 430×480×22 SBF V
240	270	15	R V	CR 240×270×15 SBF R CR 240×270×15 SBF V	440	490	25	R V	CR 440×490×25 SBF R CR 440×490×25 SBF V
240	280	16	R V	CR 240×280×16 SBF R CR 240×280×16 SBF V	450	500	25	R V	CR 450×500×25 SBF R CR 450×500×25 SBF V
245	275	16	R V	CR 245×275×16 SBF R CR 245×275×16 SBF V	900	960	27	R V	CR 900×960×27 SBF R CR 900×960×27 SBF V
260	290	16	R V	CR 260×290×16 SBF R CR 260×290×16 SBF V					
260	310	16	R V	CR 260×310×16 SBF R CR 260×310×16 SBF V					
270	235	16	R V	CR 270×235×16 SBF R CR 270×235×16 SBF V					
290	330	18	R V	CR 290×330×18 SBF R CR 290×330×18 SBF V					
290	334	20	R V	CR 290×334×20 SBF R CR 290×334×20 SBF V					
300	344	20	R V	CR 300×344×20 SBF R CR 300×344×20 SBF V					
316	360	20	R V	CR 316×360×20 SBF R CR 316×360×20 SBF V					
325	365	16	R V	CR 325×365×16 SBF R CR 325×365×16 SBF V					
340	380	20	R V	CR 340×380×20 SBF R CR 340×380×20 SBF V					
360	400	20	R V	CR 360×400×20 SBF R CR 360×400×20 SBF V					
385	430	25	R V	CR 385×430×25 SBF R CR 385×430×25 SBF V					
390	430	20	R V	CR 390×430×20 SBF R CR 390×430×20 SBF V					

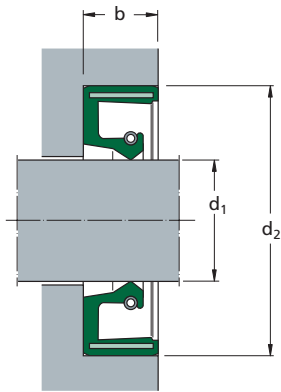

Housing dimensions			Designation	Lip material	V
shaft	bore	width			
d ₁	d ₂	b	R		
in/(mm)			–		
11.000 279,4	12.500 317,5	0.625 15,88	CR SBF 5809 R	CR SBF 5809 V	
20.500 520,7	22.500 571,5	0.875 22,23	CR SBF 7083 R	CR SBF 7083 V	
21.500 546,1	23.469 596,11	0.875 22,23	CR SBF 7175 R	CR SBF 7175 V	
23.000 584,2	24.500 622,3	0.750 19,05	CR SBF 7270 R	CR SBF 7270 V	
27.500 698,5	29.500 749,3	1.000 25,4	CR SBF 7406 R	CR SBF 7406 V	



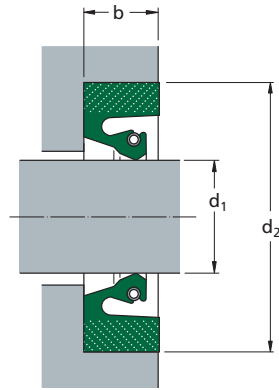

Housing dimensions			Designation Split version Lip material R Lip material V	Solid version Lip material R Lip material V
shaft	bore	width		
d ₁	d ₂	b		
mm			-	
40	60	10	CR 40×60×10 HSF1 R CR 40×60×10 HSF1 V	CR 40×60×10 HSF5 R CR 40×60×10 HSF5 V
55	80	12,2	CR 55×80×12.2 HSF1 R CR 55×80×12.2 HSF1 V	CR 55×80×12.2 HSF5 R CR 55×80×12.2 HSF5 V
60	80	10	CR 60×80×10 HSF1 R CR 60×80×10 HSF1 V	CR 60×80×10 HSF5 R CR 60×80×10 HSF5 V
70	102	12,5	CR 70×102×12.5 HSF1 R CR 70×102×12.5 HSF1 V	CR 70×102×12.5 HSF5 R CR 70×102×12.5 HSF5 V
80	100	8	CR 80×100×8 HSF1 R CR 80×100×8 HSF1 V	CR 80×100×8 HSF5 R CR 80×100×8 HSF5 V
	100	10	CR 80×100×10 HSF1 R CR 80×100×10 HSF1 V	CR 80×100×10 HSF5 R CR 80×100×10 HSF5 V
	112	12,5	CR 80×112×12.5 HSF1 R CR 80×112×12.5 HSF1 V	CR 80×112×12.5 HSF5 R CR 80×112×12.5 HSF5 V
84	100	8	CR 84×100×8 HSF1 R CR 84×100×8 HSF1 V	CR 84×100×8 HSF5 R CR 84×100×8 HSF5 V
85	101	8	CR 85×101×8 HSF1 R CR 85×101×8 HSF1 V	CR 85×101×8 HSF5 R CR 85×101×8 HSF5 V
	109	12	CR 85×109×12 HSF1 R CR 85×109×12 HSF1 V	CR 85×109×12 HSF5 R CR 85×109×12 HSF5 V
	120	12	CR 85×120×12 HSF1 R CR 85×120×12 HSF1 V	CR 85×120×12 HSF5 R CR 85×120×12 HSF5 V
90	110	12	CR 90×110×12 HSF1 R CR 90×110×12 HSF1 V	CR 90×110×12 HSF5 R CR 90×110×12 HSF5 V
	122	12,5	CR 90×122×12.5 HSF1 R CR 90×122×12.5 HSF1 V	CR 90×122×12.5 HSF5 R CR 90×122×12.5 HSF5 V
100	116	8	CR 100×116×8 HSF1 R CR 100×116×8 HSF1 V	CR 100×116×8 HSF5 R CR 100×116×8 HSF5 V
	125	10	CR 100×125×10 HSF1 R CR 100×125×10 HSF1 V	CR 100×125×10 HSF5 R CR 100×125×10 HSF5 V
	130	10	CR 100×130×10 HSF1 R CR 100×130×10 HSF1 V	CR 100×130×10 HSF5 R CR 100×130×10 HSF5 V
110	130	12	CR 110×130×12 HSF1 R CR 110×130×12 HSF1 V	CR 110×130×12 HSF5 R CR 110×130×12 HSF5 V
	140	13	CR 110×140×13 HSF1 R CR 110×140×13 HSF1 V	CR 110×140×13 HSF5 R CR 110×140×13 HSF5 V
120	150	13	CR 120×150×13 HSF1 R CR 120×150×13 HSF1 V	CR 120×150×13 HSF5 R CR 120×150×13 HSF5 V
	160	16	CR 120×160×16 HSF1 R CR 120×160×16 HSF1 V	CR 120×160×16 HSF5 R CR 120×160×16 HSF5 V

Housing dimensions			Designation Split version Lip material R Lip material V	Solid version Lip material R Lip material V
shaft	bore	width		
d ₁	d ₂	b		
mm			–	
125	155	12,5	CR 125×155×12.5 HSF1 R CR 125×155×12.5 HSF1 V	CR 125×155×12.5 HSF5 R CR 125×155×12.5 HSF5 V
	157	12,5	CR 125×157×12.5 HSF1 R CR 125×157×12.5 HSF1 V	CR 125×157×12.5 HSF5 R CR 125×157×12.5 HSF5 V
	160	12	CR 125×160×12 HSF1 R CR 125×160×12 HSF1 V	CR 125×160×12 HSF5 R CR 125×160×12 HSF5 V
127	146,05	11,11	CR 127×146.05×11.11 HSF1 R CR 127×146.05×11.11 HSF1 V	CR 127×146.05×11.11 HSF5 R CR 127×146.05×11.11 HSF5 V
	165	16	CR 127×165×16 HSF1 R CR 127×165×16 HSF1 V	CR 127×165×16 HSF5 R CR 127×165×16 HSF5 V
135	160	12	CR 135×160×12 HSF1 R CR 135×160×12 HSF1 V	CR 135×160×12 HSF5 R CR 135×160×12 HSF5 V
	170	16,5	CR 135×170×16.5 HSF1 R CR 135×170×16.5 HSF1 V	CR 135×170×16.5 HSF5 R CR 135×170×16.5 HSF5 V
140	170	12	CR 140×170×12 HSF1 R CR 140×170×12 HSF1 V	CR 140×170×12 HSF5 R CR 140×170×12 HSF5 V
	170	15	CR 140×170×15 HSF1 R CR 140×170×15 HSF1 V	CR 140×170×15 HSF5 R CR 140×170×15 HSF5 V
145	180	14	CR 145×180×14 HSF1 R CR 145×180×14 HSF1 V	CR 145×180×14 HSF5 R CR 145×180×14 HSF5 V
150	180	12	CR 150×180×12 HSF1 R CR 150×180×12 HSF1 V	CR 150×180×12 HSF5 R CR 150×180×12 HSF5 V
160	190	15	CR 160×190×15 HSF1 R CR 160×190×15 HSF1 V	CR 160×190×15 HSF5 R CR 160×190×15 HSF5 V
	190	16,5	CR 160×190×16.5 HSF1 R CR 160×190×16.5 HSF1 V	CR 160×190×16.5 HSF5 R CR 160×190×16.5 HSF5 V
	200	10	CR 160×200×10 HSF1 R CR 160×200×10 HSF1 V	CR 160×200×10 HSF5 R CR 160×200×10 HSF5 V
	200	16	CR 160×200×16 HSF1 R CR 160×200×16 HSF1 V	CR 160×200×16 HSF5 R CR 160×200×16 HSF5 V
170	200	12	CR 170×200×12 HSF1 R CR 170×200×12 HSF1 V	CR 170×200×12 HSF5 R CR 170×200×12 HSF5 V
	200	16	CR 170×200×16 HSF1 R CR 170×200×16 HSF1 V	CR 170×200×16 HSF5 R CR 170×200×16 HSF5 V
	210	16	CR 170×210×16 HSF1 R CR 170×210×16 HSF1 V	CR 170×210×16 HSF5 R CR 170×210×16 HSF5 V
	211	16	CR 170×211×16 HSF1 R CR 170×211×16 HSF1 V	CR 170×211×16 HSF5 R CR 170×211×16 HSF5 V
	200	15	CR 175×200×15 HSF1 R CR 175×200×15 HSF1 V	CR 175×200×15 HSF5 R CR 175×200×15 HSF5 V

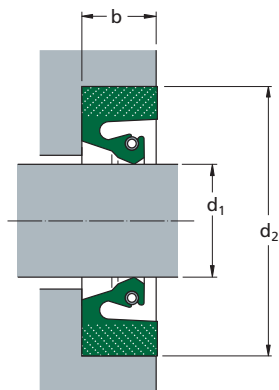

Housing dimensions			Designation Split version Lip material R Lip material V	Solid version Lip material R Lip material V
shaft	bore	width		
d ₁	d ₂	b		
mm			-	
180	200	15	CR 180×200×15 HSF1 R CR 180×200×15 HSF1 V	CR 180×200×15 HSF5 R CR 180×200×15 HSF5 V
	210	15	CR 180×210×15 HSF1 R CR 180×210×15 HSF1 V	CR 180×210×15 HSF5 R CR 180×210×15 HSF5 V
	222	16	CR 180×222×16 HSF1 R CR 180×222×16 HSF1 V	CR 180×222×16 HSF5 R CR 180×222×16 HSF5 V
185	225	16	CR 185×225×16 HSF1 R CR 185×225×16 HSF1 V	CR 185×225×16 HSF5 R CR 185×225×16 HSF5 V
190	150	16	CR 190×150×16 HSF1 R CR 190×150×16 HSF1 V	CR 190×150×16 HSF5 R CR 190×150×16 HSF5 V
	220	15	CR 190×220×15 HSF1 R CR 190×220×15 HSF1 V	CR 190×220×15 HSF5 R CR 190×220×15 HSF5 V
	225	18	CR 190×225×18 HSF1 R CR 190×225×18 HSF1 V	CR 190×225×18 HSF5 R CR 190×225×18 HSF5 V
	230	10	CR 190×230×10 HSF1 R CR 190×230×10 HSF1 V	CR 190×230×10 HSF5 R CR 190×230×10 HSF5 V
230	16	CR 190×230×16 HSF1 R CR 190×230×16 HSF1 V	CR 190×230×16 HSF5 R CR 190×230×16 HSF5 V	
200	240	16	CR 200×240×16 HSF1 R CR 200×240×16 HSF1 V	CR 200×240×16 HSF5 R CR 200×240×16 HSF5 V
	250	18	CR 200×250×18 HSF1 R CR 200×250×18 HSF1 V	CR 200×250×18 HSF5 R CR 200×250×18 HSF5 V
210	240	12	CR 210×240×12 HSF1 R CR 210×240×12 HSF1 V	CR 210×240×12 HSF5 R CR 210×240×12 HSF5 V
	245	18,2	CR 210×245×18.2 HSF1 R CR 210×245×18.2 HSF1 V	CR 210×245×18.2 HSF5 R CR 210×245×18.2 HSF5 V
	250	16	CR 210×250×16 HSF1 R CR 210×250×16 HSF1 V	CR 210×250×16 HSF5 R CR 210×250×16 HSF5 V
215	248	15	CR 215×248×15 HSF1 R CR 215×248×15 HSF1 V	CR 215×248×15 HSF5 R CR 215×248×15 HSF5 V
	250	16	CR 215×250×16 HSF1 R CR 215×250×16 HSF1 V	CR 215×250×16 HSF5 R CR 215×250×16 HSF5 V
220	180	16	CR 220×180×16 HSF1 R CR 220×180×16 HSF1 V	CR 220×180×16 HSF5 R CR 220×180×16 HSF5 V
	255	18	CR 220×255×18 HSF1 R CR 220×255×18 HSF1 V	CR 220×255×18 HSF5 R CR 220×255×18 HSF5 V
	260	16	CR 220×260×16 HSF1 R CR 220×260×16 HSF1 V	CR 220×260×16 HSF5 R CR 220×260×16 HSF5 V
	260	16,5	CR 220×260×16.5 HSF1 R CR 220×260×16.5 HSF1 V	CR 220×260×16.5 HSF5 R CR 220×260×16.5 HSF5 V
226	276	22,22	CR 226×276×22.22 HSF1 R CR 226×276×22.22 HSF1 V	CR 226×276×22.22 HSF5 R CR 226×276×22.22 HSF5 V

Housing dimensions			Designation Split version Lip material R Lip material V	Solid version Lip material R Lip material V
shaft	bore	width		
d ₁	d ₂	b		
mm			–	
230	260	15	CR 230×260×15 HSF1 R CR 230×260×15 HSF1 V	CR 230×260×15 HSF5 R CR 230×260×15 HSF5 V
	265	18	CR 230×265×18 HSF1 R CR 230×265×18 HSF1 V	CR 230×265×18 HSF5 R CR 230×265×18 HSF5 V
	270	16	CR 230×270×16 HSF1 R CR 230×270×16 HSF1 V	CR 230×270×16 HSF5 R CR 230×270×16 HSF5 V
235	265	15	CR 235×265×15 HSF1 R CR 235×265×15 HSF1 V	CR 235×265×15 HSF5 R CR 235×265×15 HSF5 V
	275	20	CR 235×275×20 HSF1 R CR 235×275×20 HSF1 V	CR 235×275×20 HSF5 R CR 235×275×20 HSF5 V
236	276	16	CR 236×276×16 HSF1 R CR 236×276×16 HSF1 V	CR 236×276×16 HSF5 R CR 236×276×16 HSF5 V
240	275	18	CR 240×275×18 HSF1 R CR 240×275×18 HSF1 V	CR 240×275×18 HSF5 R CR 240×275×18 HSF5 V
	280	16	CR 240×280×16 HSF1 R CR 240×280×16 HSF1 V	CR 240×280×16 HSF5 R CR 240×280×16 HSF5 V
	280	18	CR 240×280×18 HSF1 R CR 240×280×18 HSF1 V	CR 240×280×18 HSF5 R CR 240×280×18 HSF5 V
	290	16	CR 240×290×16 HSF1 R CR 240×290×16 HSF1 V	CR 240×290×16 HSF5 R CR 240×290×16 HSF5 V
	290	25	CR 240×290×25 HSF1 R CR 240×290×25 HSF1 V	CR 240×290×25 HSF5 R CR 240×290×25 HSF5 V
	280	15	CR 250×280×15 HSF1 R CR 250×280×15 HSF1 V	CR 250×280×15 HSF5 R CR 250×280×15 HSF5 V
250	285	18	CR 250×285×18 HSF1 R CR 250×285×18 HSF1 V	CR 250×285×18 HSF5 R CR 250×285×18 HSF5 V
	290	16,5	CR 250×290×16.5 HSF1 R CR 250×290×16.5 HSF1 V	CR 250×290×16.5 HSF5 R CR 250×290×16.5 HSF5 V
	290	18	CR 250×290×18 HSF1 R CR 250×290×18 HSF1 V	CR 250×290×18 HSF5 R CR 250×290×18 HSF5 V
	290	16	CR 260×290×16 HSF1 R CR 260×290×16 HSF1 V	CR 260×290×16 HSF5 R CR 260×290×16 HSF5 V
260	300	18	CR 260×300×18 HSF1 R CR 260×300×18 HSF1 V	CR 260×300×18 HSF5 R CR 260×300×18 HSF5 V
	304	20	CR 260×304×20 HSF1 R CR 260×304×20 HSF1 V	CR 260×304×20 HSF5 R CR 260×304×20 HSF5 V
	310	15	CR 270×310×15 HSF1 R CR 270×310×15 HSF1 V	CR 270×310×15 HSF5 R CR 270×310×15 HSF5 V
270	314	20	CR 270×314×20 HSF1 R CR 270×314×20 HSF1 V	CR 270×314×20 HSF5 R CR 270×314×20 HSF5 V
	315	20	CR 275×315×20 HSF1 R CR 275×315×20 HSF1 V	CR 275×315×20 HSF5 R CR 275×315×20 HSF5 V

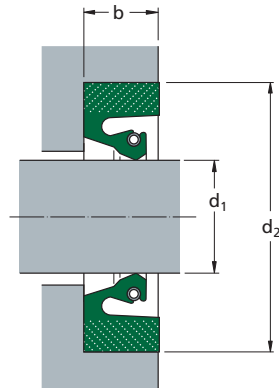

Housing dimensions			Designation	Solid version
shaft	bore	width		
d ₁	d ₂	b	Split version Lip material R Lip material V	Lip material R Lip material V
mm			-	
280	320	16	CR 280×320×16 HSF1 R CR 280×320×16 HSF1 V	CR 280×320×16 HSF5 R CR 280×320×16 HSF5 V
	320	18	CR 280×320×18 HSF1 R CR 280×320×18 HSF1 V	CR 280×320×18 HSF5 R CR 280×320×18 HSF5 V
	320	20	CR 280×320×20 HSF1 R CR 280×320×20 HSF1 V	CR 280×320×20 HSF5 R CR 280×320×20 HSF5 V
	320	24	CR 280×320×24 HSF1 R CR 280×320×24 HSF1 V	CR 280×320×24 HSF5 R CR 280×320×24 HSF5 V
	324	20	CR 280×324×20 HSF1 R CR 280×324×20 HSF1 V	CR 280×324×20 HSF5 R CR 280×324×20 HSF5 V
	350	16	CR 280×350×16 HSF1 R CR 280×350×16 HSF1 V	CR 280×350×16 HSF5 R CR 280×350×16 HSF5 V
	285	310	15	CR 285×310×15 HSF1 R CR 285×310×15 HSF1 V
289	327	19	CR 289×327×19 HSF1 R CR 289×327×19 HSF1 V	CR 289×327×19 HSF5 R CR 289×327×19 HSF5 V
290	330	20	CR 290×330×20 HSF1 R CR 290×330×20 HSF1 V	CR 290×330×20 HSF5 R CR 290×330×20 HSF5 V
	330	20,3	CR 290×330×20.3 HSF1 R CR 290×330×20.3 HSF1 V	CR 290×330×20.3 HSF5 R CR 290×330×20.3 HSF5 V
	334	20	CR 290×334×20 HSF1 R CR 290×334×20 HSF1 V	CR 290×334×20 HSF5 R CR 290×334×20 HSF5 V
292	330	15,87	CR 292×330×15.87 HSF1 R CR 292×330×15.87 HSF1 V	CR 292×330×15.87 HSF5 R CR 292×330×15.87 HSF5 V
300	340	16,5	CR 300×340×16.5 HSF1 R CR 300×340×16.5 HSF1 V	CR 300×340×16.5 HSF5 R CR 300×340×16.5 HSF5 V
	340	18	CR 300×340×18 HSF1 R CR 300×340×18 HSF1 V	CR 300×340×18 HSF5 R CR 300×340×18 HSF5 V
	340	20	CR 300×340×20 HSF1 R CR 300×340×20 HSF1 V	CR 300×340×20 HSF5 R CR 300×340×20 HSF5 V
	344	20	CR 300×344×20 HSF1 R CR 300×344×20 HSF1 V	CR 300×344×20 HSF5 R CR 300×344×20 HSF5 V
	304	348	20	CR 304×348×20 HSF1 R CR 304×348×20 HSF1 V
308	352	20	CR 308×352×20 HSF1 R CR 308×352×20 HSF1 V	CR 308×352×20 HSF5 R CR 308×352×20 HSF5 V

Housing dimensions			Designation Split version Lip material R Lip material V	Solid version Lip material R Lip material V
shaft	bore	width		
d ₁	d ₂	b		
mm			–	
310	345	18	CR 310×345×18 HSF1 R CR 310×345×18 HSF1 V	CR 310×345×18 HSF5 R CR 310×345×18 HSF5 V
	354	20	CR 310×354×20 HSF1 R CR 310×354×20 HSF1 V	CR 310×354×20 HSF5 R CR 310×354×20 HSF5 V
	354	20,5	CR 310×354×20.5 HSF1 R CR 310×354×20.5 HSF1 V	CR 310×354×20.5 HSF5 R CR 310×354×20.5 HSF5 V
	360	22	CR 310×360×22 HSF1 R CR 310×360×22 HSF1 V	CR 310×360×22 HSF5 R CR 310×360×22 HSF5 V
311	345	18,3	CR 311×345×18.3 HSF1 R CR 311×345×18.3 HSF1 V	CR 311×345×18.3 HSF5 R CR 311×345×18.3 HSF5 V
314	355	20	CR 314×355×20 HSF1 R CR 314×355×20 HSF1 V	CR 314×355×20 HSF5 R CR 314×355×20 HSF5 V
316	360	20	CR 316×360×20 HSF1 R CR 316×360×20 HSF1 V	CR 316×360×20 HSF5 R CR 316×360×20 HSF5 V
320	350	15	CR 320×350×15 HSF1 R CR 320×350×15 HSF1 V	CR 320×350×15 HSF5 R CR 320×350×15 HSF5 V
	350	15,4	CR 320×350×15.4 HSF1 R CR 320×350×15.4 HSF1 V	CR 320×350×15.4 HSF5 R CR 320×350×15.4 HSF5 V
	360	18	CR 320×360×18 HSF1 R CR 320×360×18 HSF1 V	CR 320×360×18 HSF5 R CR 320×360×18 HSF5 V
	360	20	CR 320×360×20 HSF1 R CR 320×360×20 HSF1 V	CR 320×360×20 HSF5 R CR 320×360×20 HSF5 V
328	372	20,2	CR 328×372×20.2 HSF1 R CR 328×372×20.2 HSF1 V	CR 328×372×20.2 HSF5 R CR 328×372×20.2 HSF5 V
330	370	18	CR 330×370×18 HSF1 R CR 330×370×18 HSF1 V	CR 330×370×18 HSF5 R CR 330×370×18 HSF5 V
	370	20	CR 330×370×20 HSF1 R CR 330×370×20 HSF1 V	CR 330×370×20 HSF5 R CR 330×370×20 HSF5 V
	374	20	CR 330×374×20 HSF1 R CR 330×374×20 HSF1 V	CR 330×374×20 HSF5 R CR 330×374×20 HSF5 V
	380,8	20,62	CR 330×380.8×20.62 HSF1 R CR 330×380.8×20.62 HSF1 V	CR 330×380.8×20.62 HSF5 R CR 330×380.8×20.62 HSF5 V
335	373	19	CR 335×373×19 HSF1 R CR 335×373×19 HSF1 V	CR 335×373×19 HSF5 R CR 335×373×19 HSF5 V
340	380	16	CR 340×380×16 HSF1 R CR 340×380×16 HSF1 V	CR 340×380×16 HSF5 R CR 340×380×16 HSF5 V
	380	18	CR 340×380×18 HSF1 R CR 340×380×18 HSF1 V	CR 340×380×18 HSF5 R CR 340×380×18 HSF5 V
	380	20	CR 340×380×20 HSF1 R CR 340×380×20 HSF1 V	CR 340×380×20 HSF5 R CR 340×380×20 HSF5 V
	384	20	CR 340×384×20 HSF1 R CR 340×384×20 HSF1 V	CR 340×384×20 HSF5 R CR 340×384×20 HSF5 V

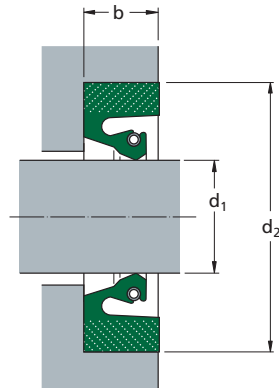

Housing dimensions			Designation Split version Lip material R Lip material V	Solid version Lip material R Lip material V
shaft	bore	width		
d ₁	d ₂	b		
mm			-	
350	380	17,7	CR 350×380×17.7 HSF1 R CR 350×380×17.7 HSF1 V	CR 350×380×17.7 HSF5 R CR 350×380×17.7 HSF5 V
	390	20	CR 350×390×20 HSF1 R CR 350×390×20 HSF1 V	CR 350×390×20 HSF5 R CR 350×390×20 HSF5 V
	394	20	CR 350×394×20 HSF1 R CR 350×394×20 HSF1 V	CR 350×394×20 HSF5 R CR 350×394×20 HSF5 V
360	404	20	CR 360×404×20 HSF1 R CR 360×404×20 HSF1 V	CR 360×404×20 HSF5 R CR 360×404×20 HSF5 V
	410	20	CR 360×410×20 HSF1 R CR 360×410×20 HSF1 V	CR 360×410×20 HSF5 R CR 360×410×20 HSF5 V
362	400	20	CR 362×400×20 HSF1 R CR 362×400×20 HSF1 V	CR 362×400×20 HSF5 R CR 362×400×20 HSF5 V
	406	19,8	CR 362×406×19.8 HSF1 R CR 362×406×19.8 HSF1 V	CR 362×406×19.8 HSF5 R CR 362×406×19.8 HSF5 V
	406	22	CR 362×406×22 HSF1 R CR 362×406×22 HSF1 V	CR 362×406×22 HSF5 R CR 362×406×22 HSF5 V
370	410	20	CR 370×410×20 HSF1 R CR 370×410×20 HSF1 V	CR 370×410×20 HSF5 R CR 370×410×20 HSF5 V
	414	20	CR 370×414×20 HSF1 R CR 370×414×20 HSF1 V	CR 370×414×20 HSF5 R CR 370×414×20 HSF5 V
380	420	20	CR 380×420×20 HSF1 R CR 380×420×20 HSF1 V	CR 380×420×20 HSF5 R CR 380×420×20 HSF5 V
	431	22,5	CR 387×431×22.5 HSF1 R CR 387×431×22.5 HSF1 V	CR 387×431×22.5 HSF5 R CR 387×431×22.5 HSF5 V
387	438	25,4	CR 387×438×25.4 HSF1 R CR 387×438×25.4 HSF1 V	CR 387×438×25.4 HSF5 R CR 387×438×25.4 HSF5 V
	430	20	CR 390×430×20 HSF1 R CR 390×430×20 HSF1 V	CR 390×430×20 HSF5 R CR 390×430×20 HSF5 V
390	430	20	CR 390×430×20 HSF1 R CR 390×430×20 HSF1 V	CR 390×430×20 HSF5 R CR 390×430×20 HSF5 V
	439	20	CR 395×439×20 HSF1 R CR 395×439×20 HSF1 V	CR 395×439×20 HSF5 R CR 395×439×20 HSF5 V
395	439	20,5	CR 395×439×20.5 HSF1 R CR 395×439×20.5 HSF1 V	CR 395×439×20.5 HSF5 R CR 395×439×20.5 HSF5 V
	440	20	CR 400×440×20 HSF1 R CR 400×440×20 HSF1 V	CR 400×440×20 HSF5 R CR 400×440×20 HSF5 V
400	444	20	CR 400×444×20 HSF1 R CR 400×444×20 HSF1 V	CR 400×444×20 HSF5 R CR 400×444×20 HSF5 V
	450	22	CR 400×450×22 HSF1 R CR 400×450×22 HSF1 V	CR 400×450×22 HSF5 R CR 400×450×22 HSF5 V
	450	22	CR 400×450×22 HSF1 R CR 400×450×22 HSF1 V	CR 400×450×22 HSF5 R CR 400×450×22 HSF5 V

Housing dimensions			Designation Split version Lip material R Lip material V	Solid version Lip material R Lip material V
shaft	bore	width		
d ₁	d ₂	b		
mm			–	
420	460	20	CR 420×460×20 HSF1 R CR 420×460×20 HSF1 V	CR 420×460×20 HSF5 R CR 420×460×20 HSF5 V
	470	22	CR 420×470×22 HSF1 R CR 420×470×22 HSF1 V	CR 420×470×22 HSF5 R CR 420×470×22 HSF5 V
	470	25	CR 420×470×25 HSF1 R CR 420×470×25 HSF1 V	CR 420×470×25 HSF5 R CR 420×470×25 HSF5 V
430	480	25	CR 430×480×25 HSF1 R CR 430×480×25 HSF1 V	CR 430×480×25 HSF5 R CR 430×480×25 HSF5 V
435	485	22	CR 435×485×22 HSF1 R CR 435×485×22 HSF1 V	CR 435×485×22 HSF5 R CR 435×485×22 HSF5 V
438	476	24	CR 438×476×24 HSF1 R CR 438×476×24 HSF1 V	CR 438×476×24 HSF5 R CR 438×476×24 HSF5 V
440	480	20	CR 440×480×20 HSF1 R CR 440×480×20 HSF1 V	CR 440×480×20 HSF5 R CR 440×480×20 HSF5 V
			480	26
	490	20		
			490	25
446	486	16,5	CR 446×486×16.5 HSF1 R CR 446×486×16.5 HSF1 V	CR 446×486×16.5 HSF5 R CR 446×486×16.5 HSF5 V
450	490	18	CR 450×490×18 HSF1 R CR 450×490×18 HSF1 V	CR 450×490×18 HSF5 R CR 450×490×18 HSF5 V
			500	20
	500	22		
			500	25
460	510	22	CR 460×510×22 HSF1 R CR 460×510×22 HSF1 V	CR 460×510×22 HSF5 R CR 460×510×22 HSF5 V
			510	25
470	520	25	CR 470×520×25 HSF1 R CR 470×520×25 HSF1 V	CR 470×520×25 HSF5 R CR 470×520×25 HSF5 V

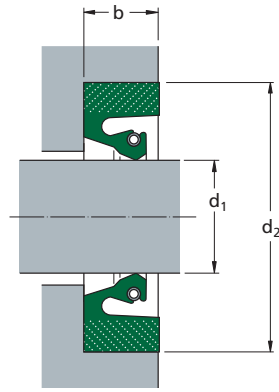

Housing dimensions			Designation Split version Lip material R Lip material V	Solid version Lip material R Lip material V
shaft	bore	width		
d_1	d_2	b		
mm			-	
480	520	18	CR 480×520×18 HSF1 R CR 480×520×18 HSF1 V	CR 480×520×18 HSF5 R CR 480×520×18 HSF5 V
	520	20	CR 480×520×20 HSF1 R CR 480×520×20 HSF1 V	CR 480×520×20 HSF5 R CR 480×520×20 HSF5 V
	530	22	CR 480×530×22 HSF1 R CR 480×530×22 HSF1 V	CR 480×530×22 HSF5 R CR 480×530×22 HSF5 V
	530	25	CR 480×530×25 HSF1 R CR 480×530×25 HSF1 V	CR 480×530×25 HSF5 R CR 480×530×25 HSF5 V
	550	25	CR 480×550×25 HSF1 R CR 480×550×25 HSF1 V	CR 480×550×25 HSF5 R CR 480×550×25 HSF5 V
	495	545	22	CR 495×545×22 HSF1 R CR 495×545×22 HSF1 V
500	540	10	CR 500×540×10 HSF1 R CR 500×540×10 HSF1 V	CR 500×540×10 HSF5 R CR 500×540×10 HSF5 V
	540	20	CR 500×540×20 HSF1 R CR 500×540×20 HSF1 V	CR 500×540×20 HSF5 R CR 500×540×20 HSF5 V
	550	20	CR 500×550×20 HSF1 R CR 500×550×20 HSF1 V	CR 500×550×20 HSF5 R CR 500×550×20 HSF5 V
	564	25	CR 500×564×25 HSF1 R CR 500×564×25 HSF1 V	CR 500×564×25 HSF5 R CR 500×564×25 HSF5 V
	520	560	18	CR 520×560×18 HSF1 R CR 520×560×18 HSF1 V
520	560	20	CR 520×560×20 HSF1 R CR 520×560×20 HSF1 V	CR 520×560×20 HSF5 R CR 520×560×20 HSF5 V
525	575	22	CR 525×575×22 HSF1 R CR 525×575×22 HSF1 V	CR 525×575×22 HSF5 R CR 525×575×22 HSF5 V
530	580	22	CR 530×580×22 HSF1 R CR 530×580×22 HSF1 V	CR 530×580×22 HSF5 R CR 530×580×22 HSF5 V
	580	22,3	CR 530×580×22.3 HSF1 R CR 530×580×22.3 HSF1 V	CR 530×580×22.3 HSF5 R CR 530×580×22.3 HSF5 V
	580	25	CR 530×580×25 HSF1 R CR 530×580×25 HSF1 V	CR 530×580×25 HSF5 R CR 530×580×25 HSF5 V
	620	22	CR 530×620×22 HSF1 R CR 530×620×22 HSF1 V	CR 530×620×22 HSF5 R CR 530×620×22 HSF5 V
	535	585	22	CR 535×585×22 HSF1 R CR 535×585×22 HSF1 V
540	590	22	CR 540×590×22 HSF1 R CR 540×590×22 HSF1 V	CR 540×590×22 HSF5 R CR 540×590×22 HSF5 V
	590	30	CR 540×590×30 HSF1 R CR 540×590×30 HSF1 V	CR 540×590×30 HSF5 R CR 540×590×30 HSF5 V
	550	600	22,3	CR 550×600×22.3 HSF1 R CR 550×600×22.3 HSF1 V

Housing dimensions			Designation	Solid version
shaft	bore	width		
d ₁	d ₂	b	Split version Lip material R Lip material V	Lip material R Lip material V
mm			–	
560	604	20	CR 560×604×20 HSF1 R CR 560×604×20 HSF1 V	CR 560×604×20 HSF5 R CR 560×604×20 HSF5 V
	610	20	CR 560×610×20 HSF1 R CR 560×610×20 HSF1 V	CR 560×610×20 HSF5 R CR 560×610×20 HSF5 V
	610	22,3	CR 560×610×22.3 HSF1 R CR 560×610×22.3 HSF1 V	CR 560×610×22.3 HSF5 R CR 560×610×22.3 HSF5 V
	610	25	CR 560×610×25 HSF1 R CR 560×610×25 HSF1 V	CR 560×610×25 HSF5 R CR 560×610×25 HSF5 V
570	616	19	CR 570×616×19 HSF1 R CR 570×616×19 HSF1 V	CR 570×616×19 HSF5 R CR 570×616×19 HSF5 V
	620	25	CR 570×620×25 HSF1 R CR 570×620×25 HSF1 V	CR 570×620×25 HSF5 R CR 570×620×25 HSF5 V
575	625	22	CR 575×625×22 HSF1 R CR 575×625×22 HSF1 V	CR 575×625×22 HSF5 R CR 575×625×22 HSF5 V
580	630	22	CR 580×630×22 HSF1 R CR 580×630×22 HSF1 V	CR 580×630×22 HSF5 R CR 580×630×22 HSF5 V
600	650	22	CR 600×650×22 HSF1 R CR 600×650×22 HSF1 V	CR 600×650×22 HSF5 R CR 600×650×22 HSF5 V
620	670	22	CR 620×670×22 HSF1 R CR 620×670×22 HSF1 V	CR 620×670×22 HSF5 R CR 620×670×22 HSF5 V
	684	25	CR 620×684×25 HSF1 R CR 620×684×25 HSF1 V	CR 620×684×25 HSF5 R CR 620×684×25 HSF5 V
625	689	25	CR 625×689×25 HSF1 R CR 625×689×25 HSF1 V	CR 625×689×25 HSF5 R CR 625×689×25 HSF5 V
630	690	30	CR 630×690×30 HSF1 R CR 630×690×30 HSF1 V	CR 630×690×30 HSF5 R CR 630×690×30 HSF5 V
635	705	30	CR 635×705×30 HSF1 R CR 635×705×30 HSF1 V	CR 635×705×30 HSF5 R CR 635×705×30 HSF5 V
650	690	18	CR 650×690×18 HSF1 R CR 650×690×18 HSF1 V	CR 650×690×18 HSF5 R CR 650×690×18 HSF5 V
660	724	25	CR 660×724×25 HSF1 R CR 660×724×25 HSF1 V	CR 660×724×25 HSF5 R CR 660×724×25 HSF5 V
670	734	25	CR 670×734×25 HSF1 R CR 670×734×25 HSF1 V	CR 670×734×25 HSF5 R CR 670×734×25 HSF5 V
685	749	25	CR 685×749×25 HSF1 R CR 685×749×25 HSF1 V	CR 685×749×25 HSF5 R CR 685×749×25 HSF5 V

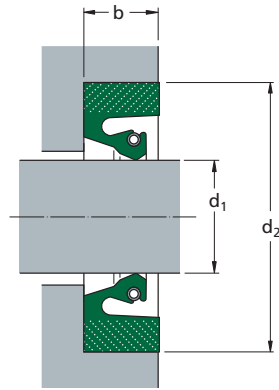

Housing dimensions			Designation	Solid version
shaft	bore	width		
d ₁	d ₂	b	Split version Lip material R Lip material V	Lip material R Lip material V
mm			-	
700	760	30	CR 700×760×30 HSF1 R CR 700×760×30 HSF1 V	CR 700×760×30 HSF5 R CR 700×760×30 HSF5 V
710	770	30	CR 710×770×30 HSF1 R CR 710×770×30 HSF1 V	CR 710×770×30 HSF5 R CR 710×770×30 HSF5 V
	774	25	CR 710×774×25 HSF1 R CR 710×774×25 HSF1 V	CR 710×774×25 HSF5 R CR 710×774×25 HSF5 V
730	794	25	CR 730×794×25 HSF1 R CR 730×794×25 HSF1 V	CR 730×794×25 HSF5 R CR 730×794×25 HSF5 V
736	800	25	CR 736×800×25 HSF1 R CR 736×800×25 HSF1 V	CR 736×800×25 HSF5 R CR 736×800×25 HSF5 V
740	785	18	CR 740×785×18 HSF1 R CR 740×785×18 HSF1 V	CR 740×785×18 HSF5 R CR 740×785×18 HSF5 V
744	808	25	CR 744×808×25 HSF1 R CR 744×808×25 HSF1 V	CR 744×808×25 HSF5 R CR 744×808×25 HSF5 V
750	810	30	CR 750×810×30 HSF1 R CR 750×810×30 HSF1 V	CR 750×810×30 HSF5 R CR 750×810×30 HSF5 V
	814	25	CR 750×814×25 HSF1 R CR 750×814×25 HSF1 V	CR 750×814×25 HSF5 R CR 750×814×25 HSF5 V
760	820	30	CR 760×820×30 HSF1 R CR 760×820×30 HSF1 V	CR 760×820×30 HSF5 R CR 760×820×30 HSF5 V
770	834	25	CR 770×834×25 HSF1 R CR 770×834×25 HSF1 V	CR 770×834×25 HSF5 R CR 770×834×25 HSF5 V
780	844	25	CR 780×844×25 HSF1 R CR 780×844×25 HSF1 V	CR 780×844×25 HSF5 R CR 780×844×25 HSF5 V
790	850	30	CR 790×850×30 HSF1 R CR 790×850×30 HSF1 V	CR 790×850×30 HSF5 R CR 790×850×30 HSF5 V
800	860	30	CR 800×860×30 HSF1 R CR 800×860×30 HSF1 V	CR 800×860×30 HSF5 R CR 800×860×30 HSF5 V
	865	25	CR 800×865×25 HSF1 R CR 800×865×25 HSF1 V	CR 800×865×25 HSF5 R CR 800×865×25 HSF5 V
810	860	25	CR 810×860×25 HSF1 R CR 810×860×25 HSF1 V	CR 810×860×25 HSF5 R CR 810×860×25 HSF5 V
	874	22	CR 810×874×22 HSF1 R CR 810×874×22 HSF1 V	CR 810×874×22 HSF5 R CR 810×874×22 HSF5 V
840	904	25	CR 840×904×25 HSF1 R CR 840×904×25 HSF1 V	CR 840×904×25 HSF5 R CR 840×904×25 HSF5 V

Housing dimensions			Designation Split version Lip material R Lip material V	Solid version Lip material R Lip material V
shaft	bore	width		
d ₁	d ₂	b		
mm			–	
850	900	22	CR 850×900×22 HSF1 R CR 850×900×22 HSF1 V	CR 850×900×22 HSF5 R CR 850×900×22 HSF5 V
	904	25	CR 850×904×25 HSF1 R CR 850×904×25 HSF1 V	CR 850×904×25 HSF5 R CR 850×904×25 HSF5 V
	910	30	CR 850×910×30 HSF1 R CR 850×910×30 HSF1 V	CR 850×910×30 HSF5 R CR 850×910×30 HSF5 V
900	960	30	CR 900×960×30 HSF1 R CR 900×960×30 HSF1 V	CR 900×960×30 HSF5 R CR 900×960×30 HSF5 V
	964	32	CR 900×964×32 HSF1 R CR 900×964×32 HSF1 V	CR 900×964×32 HSF5 R CR 900×964×32 HSF5 V
910	974	25	CR 910×974×25 HSF1 R CR 910×974×25 HSF1 V	CR 910×974×25 HSF5 R CR 910×974×25 HSF5 V
	974	25,4	CR 910×974×25.4 HSF1 R CR 910×974×25.4 HSF1 V	CR 910×974×25.4 HSF5 R CR 910×974×25.4 HSF5 V
920	984	25	CR 920×984×25 HSF1 R CR 920×984×25 HSF1 V	CR 920×984×25 HSF5 R CR 920×984×25 HSF5 V
950	1 000	25	CR 950×1000×25 HSF1 R CR 950×1000×25 HSF1 V	CR 950×1000×25 HSF5 R CR 950×1000×25 HSF5 V
	1 010	30	CR 950×1010×30 HSF1 R CR 950×1010×30 HSF1 V	CR 950×1010×30 HSF5 R CR 950×1010×30 HSF5 V
960	1 024	25	CR 960×1024×25 HSF1 R CR 960×1024×25 HSF1 V	CR 960×1024×25 HSF5 R CR 960×1024×25 HSF5 V
970	1 020	25	CR 970×1020×25 HSF1 R CR 970×1020×25 HSF1 V	CR 970×1020×25 HSF5 R CR 970×1020×25 HSF5 V
	1 034	25	CR 970×1034×25 HSF1 R CR 970×1034×25 HSF1 V	CR 970×1034×25 HSF5 R CR 970×1034×25 HSF5 V
1 000	1 064	25	CR 1000×1064×25 HSF1 R CR 1000×1064×25 HSF1 V	CR 1000×1064×25 HSF5 R CR 1000×1064×25 HSF5 V
1 016	1 043,1	13,7	CR 1016×1043.1×13.7 HSF1 R CR 1016×1043.1×13.7 HSF1 V	CR 1016×1043.1×13.7 HSF5 R CR 1016×1043.1×13.7 HSF5 V
1 110	1 174	25	CR 1110×1174×25 HSF1 R CR 1110×1174×25 HSF1 V	CR 1110×1174×25 HSF5 R CR 1110×1174×25 HSF5 V

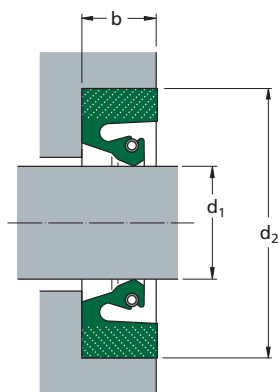

Housing dimensions			Designation	Lip material V	Solid version	
shaft	bore	width			Lip material R	Lip material V
d ₁	d ₂	b	Split version			
in/mm			-			
1.000 25,4	1.874 47,6	0.375 9,5	CR HSF1 5001 R	CR HSF1 5001 V	CR HSF5 5001 R	CR HSF5 5001 V
2.750 69,9	3.375 85,7	0.312 7,9	CR HSF1 5156 R	CR HSF1 5156 V	CR HSF5 5156 R	CR HSF5 5156 V
3.248 82,5	4.500 114,3	0.500 12,7	CR HSF1 5225 R	CR HSF1 5225 V	CR HSF5 5225 R	CR HSF5 5225 V
3.500 88,9	4.500 114,3	0.500 12,7	CR HSF1 5252 R	CR HSF1 5252 V	CR HSF5 5252 R	CR HSF5 5252 V
3.874 98,4	4.878 123,9	0.500 12,7	CR HSF1 5265 R	CR HSF1 5265 V	CR HSF5 5265 R	CR HSF5 5265 V
4.000 101,6	5.000 127	0.500 12,7	CR HSF1 5310 R	CR HSF1 5310 V	CR HSF5 5310 R	CR HSF5 5310 V
4.425 112,4	5.500 139,7	0.562 14,3	CR HSF1 5353 R	CR HSF1 5353 V	CR HSF5 5353 R	CR HSF5 5353 V
4.437 112,7	5.465 138,8	0.583 14,8	CR HSF1 5351 R	CR HSF1 5351 V	CR HSF5 5351 R	CR HSF5 5351 V
4.874 123,8	5.874 149,2	0.500 12,7	CR HSF1 5391 R	CR HSF1 5391 V	CR HSF5 5391 R	CR HSF5 5391 V
5.205 132,2	6.504 165,2	0.591 15	CR HSF1 5431 R	CR HSF1 5431 V	CR HSF5 5431 R	CR HSF5 5431 V
5.622 142,8	6.622 168,2	0.625 15,9	CR HSF1 5471 R	CR HSF1 5471 V	CR HSF5 5471 R	CR HSF5 5471 V
5.750 146,1	7.000 177,8	0.625 15,9	CR HSF1 5489 R	CR HSF1 5489 V	CR HSF5 5489 R	CR HSF5 5489 V
5.874 149,2	7.000 177,8	0.492 12,5	CR HSF1 5498 R	CR HSF1 5498 V	CR HSF5 5498 R	CR HSF5 5498 V
6.000 152,4	7.126 181	0.630 16	CR HSF1 5509 R	CR HSF1 5509 V	CR HSF5 5509 R	CR HSF5 5509 V
	7.500 190,5	0.625 15,9	CR HSF1 5510 R	CR HSF1 5510 V	CR HSF5 5510 R	CR HSF5 5510 V
6.500 165,1	8.000 203,2	0.750 19,1	CR HSF1 5570 R	CR HSF1 5570 V	CR HSF5 5570 R	CR HSF5 5570 V
6.748 171,4	7.750 196,9	0.750 19,1	CR HSF1 5585 R	CR HSF1 5585 V	CR HSF5 5585 R	CR HSF5 5585 V

Housing dimensions		width b	Designation Split version Lip material R	Lip material V	Solid version Lip material R	Lip material V
shaft d ₁	bore d ₂					
in/mm		–				
7.000 177,8	8.000	0.437	CR HSF1 5587 R	CR HSF1 5587 V	CR HSF5 5587 R	CR HSF5 5587 V
	203,2	11,1				
	8.250	0.750	CR HSF1 5600 R	CR HSF1 5600 V	CR HSF5 5600 R	CR HSF5 5600 V
	209,6	19,1				
7.250 184,2	8.500	0.625	CR HSF1 5624 R	CR HSF1 5624 V	CR HSF5 5624 R	CR HSF5 5624 V
	215,9	15,9				
7.500 190,5	8.500	0.625	CR HSF1 5662 R	CR HSF1 5662 V	CR HSF5 5662 R	CR HSF5 5662 V
	215,9	15,9				
7.677 195	8.677	0.500	CR HSF1 5667 R	CR HSF1 5667 V	CR HSF5 5667 R	CR HSF5 5667 V
	220,4	12,7				
8.598 218,4	9.843	0.591	CR HSF1 5764 R	CR HSF1 5764 V	CR HSF5 5764 R	CR HSF5 5764 V
	250	15				
8.750 222,3	10.000	0.625	CR HSF1 5790 R	CR HSF1 5790 V	CR HSF5 5790 R	CR HSF5 5790 V
	254	15,9				
9.625 244,5	11.635	1.000	CR HSF1 5878 R	CR HSF1 5878 V	CR HSF5 5878 R	CR HSF5 5878 V
	295,5	25,4				
9.843 250	10.843	0.500	CR HSF1 5885 R	CR HSF1 5885 V	CR HSF5 5885 R	CR HSF5 5885 V
	275,4	12,7				
10.000 254	11.250	0.625	CR HSF1 5910 R	CR HSF1 5910 V	CR HSF5 5910 R	CR HSF5 5910 V
	285,8	15,9				
10.250 260,4	12.250	0.750	CR HSF1 5950 R	CR HSF1 5950 V	CR HSF5 5950 R	CR HSF5 5950 V
	311,2	19,1				
11.000 279,4	12.181	0.591	CR HSF1 6000 R	CR HSF1 6000 V	CR HSF5 6000 R	CR HSF5 6000 V
	309,4	15				
11.250 285,8	12.500	0.625	CR HSF1 6040 R	CR HSF1 6040 V	CR HSF5 6040 R	CR HSF5 6040 V
	317,5	15,9				
11.260 286	13.250	0.591	CR HSF1 6049 R	CR HSF1 6049 V	CR HSF5 6049 R	CR HSF5 6049 V
	336,6	15				
11.417 290	12.417	0.500	CR HSF1 6055 R	CR HSF1 6055 V	CR HSF5 6055 R	CR HSF5 6055 V
	315,4	12,7				
12.250 311,2	14.250	0.812	CR HSF1 6150 R	CR HSF1 6150 V	CR HSF5 6150 R	CR HSF5 6150 V
	362	20,6				
12.484 317,1	14.000	0.630	CR HSF1 6172 R	CR HSF1 6172 V	CR HSF5 6172 R	CR HSF5 6172 V
	355,6	16				

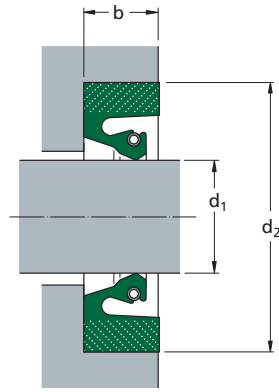

Housing dimensions		width b	Designation Split version Lip material R	Lip material V	Solid version	
shaft d ₁	bore d ₂				Lip material R	Lip material V
in/mm			–			
12.500 317,5	14.000 355,6	0.750 19,1	CR HSF1 6173 R	CR HSF1 6173 V	CR HSF5 6173 R	CR HSF5 6173 V
12.504 317,6	14.000 355,6	0.687 17,4	CR HSF1 6175 R	CR HSF1 6175 V	CR HSF5 6175 R	CR HSF5 6175 V
12.746 323,7	14.248 361,9	0.687 17,4	CR HSF1 6192 R	CR HSF1 6192 V	CR HSF5 6192 R	CR HSF5 6192 V
	14.750 374,7	1.000 25,4	CR HSF1 6195 R	CR HSF1 6195 V	CR HSF5 6195 R	CR HSF5 6195 V
13.000 330,2	14.500 368,3	0.687 17,4	CR HSF1 6230 R	CR HSF1 6230 V	CR HSF5 6230 R	CR HSF5 6230 V
	14.500 368,3	0.687 17,4	CR HSF1 6230 R	CR HSF1 6230 V	CR HSF5 6230 R	CR HSF5 6230 V
13.500 342,9	15.000 381	0.750 19,1	CR HSF1 6271 R	CR HSF1 6271 V	CR HSF5 6271 R	CR HSF5 6271 V
14.370 365	16.118 409,4	0.750 19,1	CR HSF1 6350 R	CR HSF1 6350 V	CR HSF5 6350 R	CR HSF5 6350 V
14.500 368,3	16.250 412,8	0.625 15,9	CR HSF1 6370 R	CR HSF1 6370 V	CR HSF5 6370 R	CR HSF5 6370 V
14.961 380	16.961 430,8	0.812 20,6	CR HSF1 6425 R	CR HSF1 6425 V	CR HSF5 6425 R	CR HSF5 6425 V
15.250 387,4	17.250 438,2	0.875 22,2	CR HSF1 6460 R	CR HSF1 6460 V	CR HSF5 6460 R	CR HSF5 6460 V
15.992 406,2	17.500 444,5	0.687 17,4	CR HSF1 6550 R	CR HSF1 6550 V	CR HSF5 6550 R	CR HSF5 6550 V
16.000 406,4	18.000 457,2	0.750 19,1	CR HSF1 6560 R	CR HSF1 6560 V	CR HSF5 6560 R	CR HSF5 6560 V
	18.000 457,2	0.812 20,6	CR HSF1 6565 R	CR HSF1 6565 V	CR HSF5 6565 R	CR HSF5 6565 V
	18.000 457,2	0.906 23	CR HSF1 6575 R	CR HSF1 6575 V	CR HSF5 6575 R	CR HSF5 6575 V
16.226 412,1	17.750 450,9	0.687 17,4	CR HSF1 6590 R	CR HSF1 6590 V	CR HSF5 6590 R	CR HSF5 6590 V
16.500 419,1	17.750 450,9	0.750 19,1	CR HSF1 6600 R	CR HSF1 6600 V	CR HSF5 6600 R	CR HSF5 6600 V
17.000 431,8	19.000 482,6	0.812 20,6	CR HSF1 6645 R	CR HSF1 6645 V	CR HSF5 6645 R	CR HSF5 6645 V

Housing dimensions			Designation Split version Lip material R	Lip material V	Solid version Lip material R	Lip material V
shaft d ₁	bore d ₂	width b				
in/mm			–			
17.248 438,1	18.748 476,2	0.750 19,1	CR HSF1 6656 R	CR HSF1 6656 V	CR HSF5 6656 R	CR HSF5 6656 V
18.169 461,5	21.260 540	1.220 31	CR HSF1 6734 R	CR HSF1 6734 V	CR HSF5 6734 R	CR HSF5 6734 V
20.500 520,7	22.500 571,5	1.000 25,4	CR HSF1 6890 R	CR HSF1 6890 V	CR HSF5 6890 R	CR HSF5 6890 V
21.000 533,4	23.000 584,2	0.875 22,2	CR HSF1 6930 R	CR HSF1 6930 V	CR HSF5 6930 R	CR HSF5 6930 V
22.000 558,8	24.000 609,6	0.875 22,2	CR HSF1 7000 R	CR HSF1 7000 V	CR HSF5 7000 R	CR HSF5 7000 V
23.248 590,5	25.250 641,4	0.812 20,6	CR HSF1 7100 R	CR HSF1 7100 V	CR HSF5 7100 R	CR HSF5 7100 V
23.501 596,9	22.001 558,8	0.750 19,1	CR HSF1 6990 R	CR HSF1 6990 V	CR HSF5 6990 R	CR HSF5 6990 V
30.000 762	32.500 825,5	1.000 25,4	CR HSF1 7520 R	CR HSF1 7520 V	CR HSF5 7520 R	CR HSF5 7520 V
30.461 773,7	32.500 825,5	0.906 23	CR HSF1 7525 R	CR HSF1 7525 V	CR HSF5 7525 R	CR HSF5 7525 V
31.000 787,4	33.000 838,2	0.906 23	CR HSF1 7570 R	CR HSF1 7570 V	CR HSF5 7570 R	CR HSF5 7570 V
31.250 793,8	33.250 844,6	0.750 19,1	CR HSF1 7580 R	CR HSF1 7580 V	CR HSF5 7580 R	CR HSF5 7580 V
32.500 825,5	34.500 876,3	0.875 22,2	CR HSF1 7700 R	CR HSF1 7700 V	CR HSF5 7700 R	CR HSF5 7700 V
	34.500 876,3	1.000 25,4	CR HSF1 7710 R	CR HSF1 7710 V	CR HSF5 7710 R	CR HSF5 7710 V
33.000 838,2	35.000 889	0.906 23	CR HSF1 7730 R	CR HSF1 7730 V	CR HSF5 7730 R	CR HSF5 7730 V
34.375 873,1	36.875 936,6	1.250 31,8	CR HSF1 7810 R	CR HSF1 7810 V	CR HSF5 7810 R	CR HSF5 7810 V
36.500 927,1	39.000 990,6	1.250 31,8	CR HSF1 7895 R	CR HSF1 7895 V	CR HSF5 7895 R	CR HSF5 7895 V
36.748 933,4	38.749 984,2	0.875 22,2	CR HSF1 7900 R	CR HSF1 7900 V	CR HSF5 7900 R	CR HSF5 7900 V

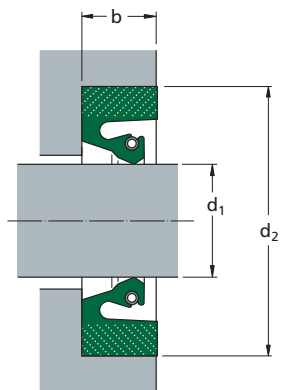

Housing dimensions			Designation	Lip material V	Solid version	Lip material V
shaft	bore	width				
d ₁	d ₂	b	Lip material R			
in/mm			-			
38.000 965,2	40.000 1 016	0.875 22,2	CR HSF1 7990 R	CR HSF1 7990 V	CR HSF5 7990 R	CR HSF5 7990 V
39.118 993,6	40.000 1 016	0.500 12,7	CR HSF1 8170 R	CR HSF1 8170 V	CR HSF5 8170 R	CR HSF5 8170 V
48.000 1 219,2	49.000 1 244,6	1.260 32	CR HSF1 8400 R	CR HSF1 8400 V	CR HSF5 8400 R	CR HSF5 8400 V

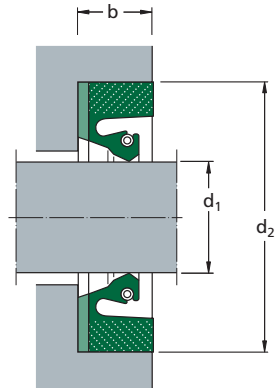

Housing dimensions			Designation	
shaft	bore	width	Split version (HSF2)	Solid version (HSF6)
d ₁	d ₂	b	Lip material R Lip material V	Lip material R Lip material V
mm			–	
127	158,8	12,3	CR 127×158.8×12.3 HSF2 R CR 127×158.8×12.3 HSF2 V	CR 127×158.8×12.3 HSF6 R CR 127×158.8×12.3 HSF6 V
275	319,5	19	CR 275×319.5×19 HSF2 R CR 275×319.5×19 HSF2 V	CR 275×319.5×19 HSF6 R CR 275×319.5×19 HSF6 V
320	364	18	CR 320×364×18 HSF2 R CR 320×364×18 HSF2 V	CR 320×364×18 HSF6 R CR 320×364×18 HSF6 V
800	864	21,6	CR 800×864×21.6 HSF2 R CR 800×864×21.6 HSF2 V	CR 800×864×21.6 HSF6 R CR 800×864×21.6 HSF6 V

Housing dimensions			Designation		Solid version	
shaft	bore	width	Split version	Lip material V	Lip material R	Lip material V
d ₁	d ₂	b	Lip material R			
in/mm			–			
21.000 533,40	23.000 584,20	0.875 22,23	CR HSF2 6930 R	CR HSF2 6930 V	CR HSF6 6930 R	CR HSF6 6930 V

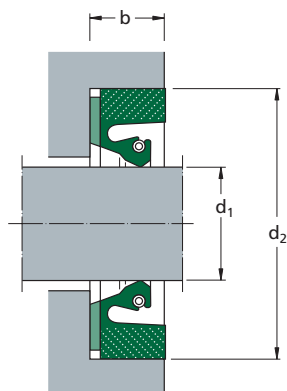

Housing dimensions			Designation Split version Lip material R Lip material V	Solid version Lip material R Lip material V
shaft	bore	width		
d ₁	d ₂	b		
mm			-	
80	95	10	CR 80×95×10 HSF3 R CR 80×95×10 HSF3 V	CR 80×95×10 HSF7 R CR 80×95×10 HSF7 V
100	130	12,5	CR 100×130×12.5 HSF3 R CR 100×130×12.5 HSF3 V	CR 100×130×12.5 HSF7 R CR 100×130×12.5 HSF7 V
140	180	16	CR 140×180×16 HSF3 R CR 140×180×16 HSF3 V	CR 140×180×16 HSF7 R CR 140×180×16 HSF7 V
150	190	16	CR 150×190×16 HSF3 R CR 150×190×16 HSF3 V	CR 150×190×16 HSF7 R CR 150×190×16 HSF7 V
160	200	16	CR 160×200×16 HSF3 R CR 160×200×16 HSF3 V	CR 160×200×16 HSF7 R CR 160×200×16 HSF7 V
165	195	15	CR 165×195×15 HSF3 R CR 165×195×15 HSF3 V	CR 165×195×15 HSF7 R CR 165×195×15 HSF7 V
220	250	15	CR 220×250×15 HSF3 R CR 220×250×15 HSF3 V	CR 220×250×15 HSF7 R CR 220×250×15 HSF7 V
	260	18	CR 220×260×18 HSF3 R CR 220×260×18 HSF3 V	CR 220×260×18 HSF7 R CR 220×260×18 HSF7 V
230	270	16	CR 230×270×16 HSF3 R CR 230×270×16 HSF3 V	CR 230×270×16 HSF7 R CR 230×270×16 HSF7 V
235	265	15,3	CR 235×265×15.3 HSF3 R CR 235×265×15.3 HSF3 V	CR 235×265×15.3 HSF7 R CR 235×265×15.3 HSF7 V
240	280	18	CR 240×280×18 HSF3 R CR 240×280×18 HSF3 V	CR 240×280×18 HSF7 R CR 240×280×18 HSF7 V
	290	25	CR 240×290×25 HSF3 R CR 240×290×25 HSF3 V	CR 240×290×25 HSF7 R CR 240×290×25 HSF7 V
245	285	16	CR 245×285×16 HSF3 R CR 245×285×16 HSF3 V	CR 245×285×16 HSF7 R CR 245×285×16 HSF7 V
250	280	16	CR 250×280×16 HSF3 R CR 250×280×16 HSF3 V	CR 250×280×16 HSF7 R CR 250×280×16 HSF7 V
	290	16,5	CR 250×290×16.5 HSF3 R CR 250×290×16.5 HSF3 V	CR 250×290×16.5 HSF7 R CR 250×290×16.5 HSF7 V
270	310	18	CR 270×310×18 HSF3 R CR 270×310×18 HSF3 V	CR 270×310×18 HSF7 R CR 270×310×18 HSF7 V
280	320	18	CR 280×320×18 HSF3 R CR 280×320×18 HSF3 V	CR 280×320×18 HSF7 R CR 280×320×18 HSF7 V
285	325	18	CR 285×325×18 HSF3 R CR 285×325×18 HSF3 V	CR 285×325×18 HSF7 R CR 285×325×18 HSF7 V

Housing dimensions			Designation Split version Lip material R Lip material V	Solid version Lip material R Lip material V
shaft	bore	width		
d ₁	d ₂	b		
mm			–	
290	334	20,3	CR 290×334×20.3 HSF3 R CR 290×334×20.3 HSF3 V	CR 290×334×20.3 HSF7 R CR 290×334×20.3 HSF7 V
300	340	16,5	CR 300×340×16.5 HSF3 R CR 300×340×16.5 HSF3 V	CR 300×340×16.5 HSF7 R CR 300×340×16.5 HSF7 V
	340	18	CR 300×340×18 HSF3 R CR 300×340×18 HSF3 V	CR 300×340×18 HSF7 R CR 300×340×18 HSF7 V
	344	20	CR 300×344×20 HSF3 R CR 300×344×20 HSF3 V	CR 300×344×20 HSF7 R CR 300×344×20 HSF7 V
310	353	20	CR 310×353×20 HSF3 R CR 310×353×20 HSF3 V	CR 310×353×20 HSF7 R CR 310×353×20 HSF7 V
	354	20	CR 310×354×20 HSF3 R CR 310×354×20 HSF3 V	CR 310×354×20 HSF7 R CR 310×354×20 HSF7 V
315	360	20	CR 315×360×20 HSF3 R CR 315×360×20 HSF3 V	CR 315×360×20 HSF7 R CR 315×360×20 HSF7 V
320	350	15	CR 320×350×15 HSF3 R CR 320×350×15 HSF3 V	CR 320×350×15 HSF7 R CR 320×350×15 HSF7 V
	360	17,7	CR 320×360×17.7 HSF3 R CR 320×360×17.7 HSF3 V	CR 320×360×17.7 HSF7 R CR 320×360×17.7 HSF7 V
325	365	16	CR 325×365×16 HSF3 R CR 325×365×16 HSF3 V	CR 325×365×16 HSF7 R CR 325×365×16 HSF7 V
330	370	20	CR 330×370×20 HSF3 R CR 330×370×20 HSF3 V	CR 330×370×20 HSF7 R CR 330×370×20 HSF7 V
	374	20	CR 330×374×20 HSF3 R CR 330×374×20 HSF3 V	CR 330×374×20 HSF7 R CR 330×374×20 HSF7 V
340	372	16	CR 340×372×16 HSF3 R CR 340×372×16 HSF3 V	CR 340×372×16 HSF7 R CR 340×372×16 HSF7 V
345	389	20	CR 345×389×20 HSF3 R CR 345×389×20 HSF3 V	CR 345×389×20 HSF7 R CR 345×389×20 HSF7 V
350	390	18	CR 350×390×18 HSF3 R CR 350×390×18 HSF3 V	CR 350×390×18 HSF7 R CR 350×390×18 HSF7 V
	394	20	CR 350×394×20 HSF3 R CR 350×394×20 HSF3 V	CR 350×394×20 HSF7 R CR 350×394×20 HSF7 V
	394	22	CR 350×394×22 HSF3 R CR 350×394×22 HSF3 V	CR 350×394×22 HSF7 R CR 350×394×22 HSF7 V
360	404	20	CR 360×404×20 HSF3 R CR 360×404×20 HSF3 V	CR 360×404×20 HSF7 R CR 360×404×20 HSF7 V
365	409,4	19,05	CR 365×409.4×19.05 HSF3 R CR 365×409.4×19.05 HSF3 V	CR 365×409.4×19.05 HSF7 R CR 365×409.4×19.05 HSF7 V

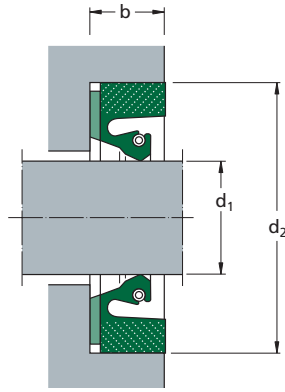

Housing dimensions			Designation Split version Lip material R Lip material V	Solid version Lip material R Lip material V
shaft	bore	width		
d_1	d_2	b		
mm			-	
366	410	20	CR 366×410×20 HSF3 R CR 366×410×20 HSF3 V	CR 366×410×20 HSF7 R CR 366×410×20 HSF7 V
370	410	18	CR 370×410×18 HSF3 R CR 370×410×18 HSF3 V	CR 370×410×18 HSF7 R CR 370×410×18 HSF7 V
380	419	24	CR 380×419×24 HSF3 R CR 380×419×24 HSF3 V	CR 380×419×24 HSF7 R CR 380×419×24 HSF7 V
	424	20	CR 380×424×20 HSF3 R CR 380×424×20 HSF3 V	CR 380×424×20 HSF7 R CR 380×424×20 HSF7 V
385	425	18,3	CR 385×425×18.3 HSF3 R CR 385×425×18.3 HSF3 V	CR 385×425×18.3 HSF7 R CR 385×425×18.3 HSF7 V
387	431	22,5	CR 387×431×22.5 HSF3 R CR 387×431×22.5 HSF3 V	CR 387×431×22.5 HSF7 R CR 387×431×22.5 HSF7 V
390	430	18	CR 390×430×18 HSF3 R CR 390×430×18 HSF3 V	CR 390×430×18 HSF7 R CR 390×430×18 HSF7 V
400	440	18	CR 400×440×18 HSF3 R CR 400×440×18 HSF3 V	CR 400×440×18 HSF7 R CR 400×440×18 HSF7 V
	440	22	CR 400×440×22 HSF3 R CR 400×440×22 HSF3 V	CR 400×440×22 HSF7 R CR 400×440×22 HSF7 V
	444	20	CR 400×444×20 HSF3 R CR 400×444×20 HSF3 V	CR 400×444×20 HSF7 R CR 400×444×20 HSF7 V
	450	22	CR 400×450×22 HSF3 R CR 400×450×22 HSF3 V	CR 400×450×22 HSF7 R CR 400×450×22 HSF7 V
420	470	22	CR 420×470×22 HSF3 R CR 420×470×22 HSF3 V	CR 420×470×22 HSF7 R CR 420×470×22 HSF7 V
430	480	22	CR 430×480×22 HSF3 R CR 430×480×22 HSF3 V	CR 430×480×22 HSF7 R CR 430×480×22 HSF7 V
440	490	22	CR 440×490×22 HSF3 R CR 440×490×22 HSF3 V	CR 440×490×22 HSF7 R CR 440×490×22 HSF7 V
450	494	20	CR 450×494×20 HSF3 R CR 450×494×20 HSF3 V	CR 450×494×20 HSF7 R CR 450×494×20 HSF7 V
460	510	22	CR 460×510×22 HSF3 R CR 460×510×22 HSF3 V	CR 460×510×22 HSF7 R CR 460×510×22 HSF7 V
	510	22	CR 460×510×22 HSF3 R CR 460×510×22 HSF3 V	CR 460×510×22 HSF7 R CR 460×510×22 HSF7 V
480	530	22	CR 480×530×22 HSF3 R CR 480×530×22 HSF3 V	CR 480×530×22 HSF7 R CR 480×530×22 HSF7 V

Housing dimensions			Designation Split version Lip material R Lip material V	Solid version Lip material R Lip material V
shaft	bore	width		
d ₁	d ₂	b		
mm			–	
500	544	20	CR 500×544×20 HSF3 R CR 500×544×20 HSF3 V	CR 500×544×20 HSF7 R CR 500×544×20 HSF7 V
515	555	20	CR 515×555×20 HSF3 R CR 515×555×20 HSF3 V	CR 515×555×20 HSF7 R CR 515×555×20 HSF7 V
520	564	20	CR 520×564×20 HSF3 R CR 520×564×20 HSF3 V	CR 520×564×20 HSF7 R CR 520×564×20 HSF7 V
	570	22	CR 520×570×22 HSF3 R CR 520×570×22 HSF3 V	CR 520×570×22 HSF7 R CR 520×570×22 HSF7 V
530	580	22	CR 530×580×22 HSF3 R CR 530×580×22 HSF3 V	CR 530×580×22 HSF7 R CR 530×580×22 HSF7 V
		25	CR 540×590×22 HSF3 R CR 540×590×22 HSF3 V CR 540×590×25 HSF3 R CR 540×590×25 HSF3 V	CR 540×590×22 HSF7 R CR 540×590×22 HSF7 V CR 540×590×25 HSF7 R CR 540×590×25 HSF7 V
545	596,9	19,05	CR 545×596.9×19.05 HSF3 R CR 545×596.9×19.05 HSF3 V	CR 545×596.9×19.05 HSF7 R CR 545×596.9×19.05 HSF7 V
550	600	22	CR 550×600×22 HSF3 R CR 550×600×22 HSF3 V	CR 550×600×22 HSF7 R CR 550×600×22 HSF7 V
560	603	20	CR 560×603×20 HSF3 R CR 560×603×20 HSF3 V	CR 560×603×20 HSF7 R CR 560×603×20 HSF7 V
	604	20	CR 560×604×20 HSF3 R CR 560×604×20 HSF3 V	CR 560×604×20 HSF7 R CR 560×604×20 HSF7 V
580	630	22	CR 580×630×22 HSF3 R CR 580×630×22 HSF3 V	CR 580×630×22 HSF7 R CR 580×630×22 HSF7 V
590	640	22	CR 590×640×22 HSF3 R CR 590×640×22 HSF3 V	CR 590×640×22 HSF7 R CR 590×640×22 HSF7 V
600	640	18	CR 600×640×18 HSF3 R CR 600×640×18 HSF3 V	CR 600×640×18 HSF7 R CR 600×640×18 HSF7 V
614	658	20	CR 614×658×20 HSF3 R CR 614×658×20 HSF3 V	CR 614×658×20 HSF7 R CR 614×658×20 HSF7 V
620	670	22	CR 620×670×22 HSF3 R CR 620×670×22 HSF3 V	CR 620×670×22 HSF7 R CR 620×670×22 HSF7 V
640	680	20	CR 640×680×20 HSF3 R CR 640×680×20 HSF3 V	CR 640×680×20 HSF7 R CR 640×680×20 HSF7 V
650	700	22	CR 650×700×22 HSF3 R CR 650×700×22 HSF3 V	CR 650×700×22 HSF7 R CR 650×700×22 HSF7 V

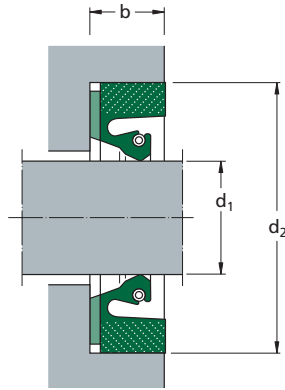

Housing dimensions			Designation	Solid version
shaft	bore	width		
d ₁	d ₂	b	Split version Lip material R Lip material V	Lip material R Lip material V
mm			-	
660	700	18	CR 660×700×18 HSF3 R CR 660×700×18 HSF3 V	CR 660×700×18 HSF7 R CR 660×700×18 HSF7 V
665	715	22	CR 665×715×22 HSF3 R CR 665×715×22 HSF3 V	CR 665×715×22 HSF7 R CR 665×715×22 HSF7 V
670	714	22	CR 670×714×22 HSF3 R CR 670×714×22 HSF3 V	CR 670×714×22 HSF7 R CR 670×714×22 HSF7 V
700	764	25	CR 700×764×25 HSF3 R CR 700×764×25 HSF3 V	CR 700×764×25 HSF7 R CR 700×764×25 HSF7 V
710	774	25	CR 710×774×25 HSF3 R CR 710×774×25 HSF3 V	CR 710×774×25 HSF7 R CR 710×774×25 HSF7 V
724	775	22	CR 724×775×22 HSF3 R CR 724×775×22 HSF3 V	CR 724×775×22 HSF7 R CR 724×775×22 HSF7 V
740	780	16,5	CR 740×780×16.5 HSF3 R CR 740×780×16.5 HSF3 V	CR 740×780×16.5 HSF7 R CR 740×780×16.5 HSF7 V
750	814	28	CR 750×814×28 HSF3 R CR 750×814×28 HSF3 V	CR 750×814×28 HSF7 R CR 750×814×28 HSF7 V
775	839	25	CR 775×839×25 HSF3 R CR 775×839×25 HSF3 V	CR 775×839×25 HSF7 R CR 775×839×25 HSF7 V
790	834	25	CR 790×834×25 HSF3 R CR 790×834×25 HSF3 V	CR 790×834×25 HSF7 R CR 790×834×25 HSF7 V
	854	25	CR 790×854×25 HSF3 R CR 790×854×25 HSF3 V	CR 790×854×25 HSF7 R CR 790×854×25 HSF7 V
800	864	25	CR 800×864×25 HSF3 R CR 800×864×25 HSF3 V	CR 800×864×25 HSF7 R CR 800×864×25 HSF7 V
840	880	18	CR 840×880×18 HSF3 R CR 840×880×18 HSF3 V	CR 840×880×18 HSF7 R CR 840×880×18 HSF7 V
880	944	25,4	CR 880×944×25.4 HSF3 R CR 880×944×25.4 HSF3 V	CR 880×944×25.4 HSF7 R CR 880×944×25.4 HSF7 V
890	930	18	CR 890×930×18 HSF3 R CR 890×930×18 HSF3 V	CR 890×930×18 HSF7 R CR 890×930×18 HSF7 V
910	974	25	CR 910×974×25 HSF3 R CR 910×974×25 HSF3 V	CR 910×974×25 HSF7 R CR 910×974×25 HSF7 V
970	1 034	25	CR 970×1034×25 HSF3 R CR 970×1034×25 HSF3 V	CR 970×1034×25 HSF7 R CR 970×1034×25 HSF7 V

Housing dimensions			Designation Split version Lip material R Lip material V	Solid version Lip material R Lip material V
shaft	bore	width		
d ₁	d ₂	b		
mm			–	
985	1 045	25	CR 985×1045×25 HSF3 R CR 985×1045×25 HSF3 V	CR 985×1045×25 HSF7 R CR 985×1045×25 HSF7 V
1 030	970	21,5	CR 1030×970×21.5 HSF3 R CR 1030×970×21.5 HSF3 V	CR 1030×970×21.5 HSF7 R CR 1030×970×21.5 HSF7 V

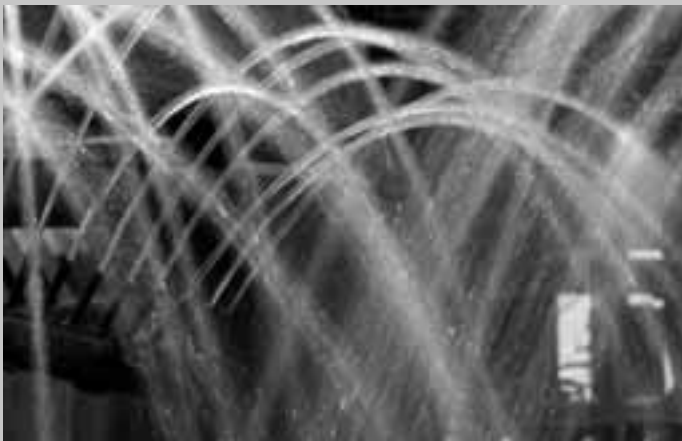

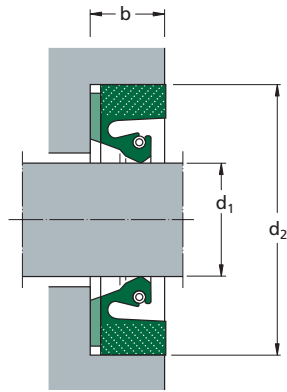

Housing dimensions		width b	Designation Split version (HSF3) Lip material R	Lip material V	Solid version (HSF7)	
shaft d ₁	bore d ₂				Lip material R	Lip material V
in/mm			–			
8.500 215,9	9.750 247,65	0.812 20,62	CR HSF3 5766 R	CR HSF3 5766 V	CR HSF7 5766 R	CR HSF7 5766 V
10.000 254,00	11.500 292,10	0.630 16,00	CR HSF3 5920 R	CR HSF3 5920 V	CR HSF7 5920 R	CR HSF7 5920 V
11.500 292,10	13.780 350,01	0.630 16,00	CR HSF3 6075 R	CR HSF3 6075 V	CR HSF7 6075 R	CR HSF7 6075 V
12.250 311,15	14.250 361,95	0.812 20,62	CR HSF3 6150 R	CR HSF3 6150 V	CR HSF7 6150 R	CR HSF7 6150 V
14.500 368,30	16.500 419,10	0.812 20,62	CR HSF3 6370 R	CR HSF3 6370 V	CR HSF7 6370 R	CR HSF7 6370 V
	16.500 419,10	1.152 29,26	CR HSF3 6375 R	CR HSF3 6375 V	CR HSF7 6375 R	CR HSF7 6375 V
14.750 374,65	16.500 419,10	0.875 22,23	CR HSF3 6395 R	CR HSF3 6395 V	CR HSF7 6395 R	CR HSF7 6395 V
15.250 387,35	17.250 438,15	1.000 25,40	CR HSF3 6465 R	CR HSF3 6465 V	CR HSF7 6465 R	CR HSF7 6465 V
16.500 419,10	18.000 457,20	0.750 19,05	CR HSF3 6611 R	CR HSF3 6611 V	CR HSF7 6611 R	CR HSF7 6611 V
35.500 901,70	37.500 952,50	0.875 22,23	CR HSF3 7860 R	CR HSF3 7860 V	CR HSF7 7860 R	CR HSF7 7860 V
36.000 914,40	38.500 977,90	0.875 22,23	CR HSF3 7890 R	CR HSF3 7890 V	CR HSF7 7890 R	CR HSF7 7890 V
45.500 1 155,70	47.000 1 193,80	0.812 20,62	CR HSF3 9000 R	CR HSF3 9000 V	CR HSF7 9000 R	CR HSF7 9000 V

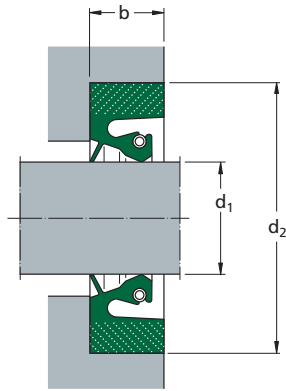

Housing dimensions			Designation		Solid version	
shaft	bore	width	Split version	Lip material R	Lip material V	
d ₁	d ₂	b				
mm			–			
75	107	12,5	CR 75×107×12.5 HSF4 R			CR 75×107×12.5 HSF8 R
			CR 75×107×12.5 HSF4 V			CR 75×107×12.5 HSF8 V
105	145	16	CR 105×145×16 HSF4 R			CR 105×145×16 HSF8 R
			CR 105×145×16 HSF4 V			CR 105×145×16 HSF8 V
215	250	16	CR 215×250×16 HSF4 R			CR 215×250×16 HSF8 R
	340	16	CR 215×250×16 HSF4 V			CR 215×250×16 HSF8 V
300	340	16	CR 300×340×16 HSF4 R			CR 300×340×16 HSF8 R
			CR 300×340×16 HSF4 V			CR 300×340×16 HSF8 V
330	374	20	CR 330×374×20 HSF4 R			CR 330×374×20 HSF8 R
			CR 330×374×20 HSF4 V			CR 330×374×20 HSF8 V
370	410	15	CR 370×410×15 HSF4 R			CR 370×410×15 HSF8 R
	420	20	CR 370×410×15 HSF4 V			CR 370×410×15 HSF8 V
380	420	22	CR 380×420×22 HSF4 R			CR 380×420×22 HSF8 R
	490	20	CR 380×420×22 HSF4 V			CR 380×420×22 HSF8 V
440	490	22	CR 440×490×20 HSF4 R			CR 440×490×20 HSF8 R
			CR 440×490×20 HSF4 V			CR 440×490×20 HSF8 V
450	500	22	CR 450×500×22 HSF4 R			CR 450×500×22 HSF8 R
			CR 450×500×22 HSF4 V			CR 450×500×22 HSF8 V
460	500	16	CR 460×500×16 HSF4 R			CR 460×500×16 HSF8 R
			CR 460×500×16 HSF4 V			CR 460×500×16 HSF8 V
500	540	22	CR 500×540×22 HSF4 R			CR 500×540×22 HSF8 R
			CR 500×540×22 HSF4 V			CR 500×540×22 HSF8 V
660	704	20	CR 660×704×20 HSF4 R			CR 660×704×20 HSF8 R
			CR 660×704×20 HSF4 V			CR 660×704×20 HSF8 V
in/mm			–			

7.250	5.750	0.625	HSF4 5490 R	HSF4 5490 V	HSF8 5490 R	HSF8 5490 V
184,15	146,05	15,88				
38.000	40.000	0.875	HSF4 7990 R	HSF4 7990 V	HSF8 7990 R	HSF8 7990 V
965,2	1 016	22,23				

I_5399_143_0312.eps

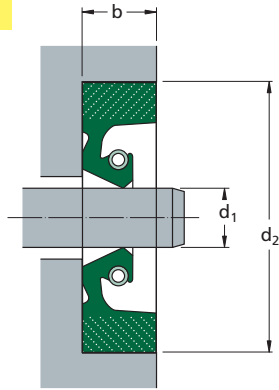

Housing dimensions			Designation Lip material R	Lip material V
shaft	bore	width		
d ₁	d ₂	b		
mm			-	
200	240	16,5	CR 200×240×16.5 HSF9 R	CR 200×240×16.5 HSF9 V
335	379	20	CR 335×379×20 HSF9 R	CR 335×379×20 HSF9 V
346	390	18	CR 346×390×18 HSF9 R	CR 346×390×18 HSF9 V
360	404	17,45	CR 360×404×17.45 HSF9 R	CR 360×404×17.45 HSF9 V
480	530	22	CR 480×530×22 HSF9 R	CR 480×530×22 HSF9 V
500	540	20	CR 500×540×20 HSF9 R	CR 500×540×20 HSF9 V
515	555	20	CR 515×555×20 HSF9 R	CR 515×555×20 HSF9 V
600	644	20	CR 600×644×20 HSF9 R	CR 600×644×20 HSF9 V
700	750	25	CR 700×750×25 HSF9 R	CR 700×750×25 HSF9 V
751	814	25,4	CR 751×814×25.4 HSF9 R	CR 751×814×25.4 HSF9 V
840	904	25	CR 840×904×25 HSF9 R	CR 840×904×25 HSF9 V
860	924	25	CR 860×924×25 HSF9 R	CR 860×924×25 HSF9 V



I_5399_143_0312.eps

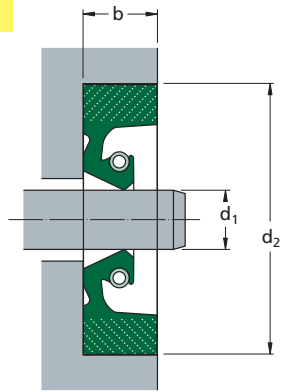

Housing dimensions			Designation Lip material R	Lip material V
shaft	bore	depth		
d_1	d_2	b		
mm			-	
17.875 454,03	19.850 504,19	0.812 20,62	CR HSF9 6715 R	CR HSF9 6715 V
25.996 660,30	28.000 711,20	1.000 25,40	CR HSF9 7233 R	CR HSF9 7233 V

SKF – THE KNOWLEDGE ENGINEERING COMPANY

The business of the SKF Group consists of the design, manufacture and marketing of the world's leading brand of rolling bearings, with a global leadership position in complementary products such as radial seals. SKF also holds an increasingly important position in the market for linear motion products, high precision aerospace bearings, machine tool spindles, plant maintenance services and is an established producer of high-quality bearing steel.

The SKF Group maintains specialized businesses to meet the needs of the global marketplace. SKF supports specific market segments with ongoing research and development efforts that have led to a growing number of innovations, new standards and new products.

SKF Group has global ISO 14001 environmental certification. Individual divisions have been approved for quality certification in accordance with either ISO 9000 or appropriate industry specific standards.

Some 80 manufacturing sites worldwide and sales companies in 70 countries make SKF a truly international corporation. In addition, our 7 000 distributor and dealer partners around the world, e-business marketplace and global distribution system put SKF close to customers for the supply of both products and services. In essence, SKF solutions are available wherever and whenever our customers need them.

Overall, the SKF brand now stands for more than ever before. It stands for the knowledge engineering company ready to serve you with world-class product competences, intellectual resources and the vision to help you succeed.



Harnessing wind power

The growing industry of wind-generated electric power provides an environmentally compatible source of electricity. SKF is working closely with global industry leaders to develop efficient and trouble-free turbines, using SKF knowledge to provide highly specialized bearings and condition monitoring systems to extend equipment life in the extreme and often remote environments of wind farms.

Developing a cleaner cleaner

The electric motor and its bearings are the heart of many household appliances. SKF works closely with appliance manufacturers to improve their product's performance, cut costs and reduce weight. A recent



example produced a new generation of vacuum cleaners with substantially more suction. SKF's knowledge in small bearing technology is also applied to manufacturers of power tools and office equipment.



Delivering asset efficiency optimization

To optimize efficiency and boost productivity, many industrial facilities outsource some or all of their maintenance services to SKF, often with guaranteed performance contracts. Through the specialized capabilities and knowledge available

from SKF Reliability Systems, SKF provides a comprehensive range of asset efficiency services, from maintenance strategies and engineering assistance, to operator-driven reliability and machine maintenance programs.



Creating a new “cold remedy”

In the frigid winters of northern China, sub-zero temperatures can cause rail car wheel assemblies and their bearings to seize due to lubrication starvation. SKF created a new family of synthetic lubricants formulated to retain their lubrication viscosity even at these extreme bearing temperatures. SKF's knowledge of lubricants and friction are unmatched throughout the world.



Planning for sustainable growth

By their very nature, bearings make a positive contribution to the natural environment. Reduced friction enables machinery to operate more efficiently, consume less power and require less lubrication. SKF is continually raising the performance bar, enabling new generations of high-efficiency products and equipment. With an eye to the future, SKF's global policies and manufacturing techniques are planned and implemented to help protect and preserve the earth's limited natural resources. We remain committed to sustainable, environmentally responsible growth.

Evolving by-wire technology

SKF has unique expertise and knowledge in fast growing by-wire technology, from fly-by-wire, to drive-by-wire, to work-by-wire. SKF pioneered practical fly-by-wire technology and is a close working partner with all aerospace industry leaders. As an example, virtually all aircraft of the Airbus design use SKF by-wire systems for cockpit flight control. SKF is also a leader in automotive drive-by-wire,

having jointly developed the revolutionary Filo and Novanta concept cars which employ SKF mechatronics for steering and braking. Further by-wire development has led SKF to produce an all-electric forklift truck which uses mechatronics rather than hydraulics for all controls.



Maintaining a 320 km/h R&D lab

In addition to SKF's renowned research and development facilities in Europe and the United States, Formula One car racing provides a unique environment for SKF to push the limits of bearing technology. For over 50 years, SKF products, engineering and knowledge have helped

make Scuderia Ferrari a formidable force in F1 racing. (The average racing Ferrari utilizes more than 150 SKF components.) Lessons learned here are applied to the products we provide to automakers and the after-market worldwide.

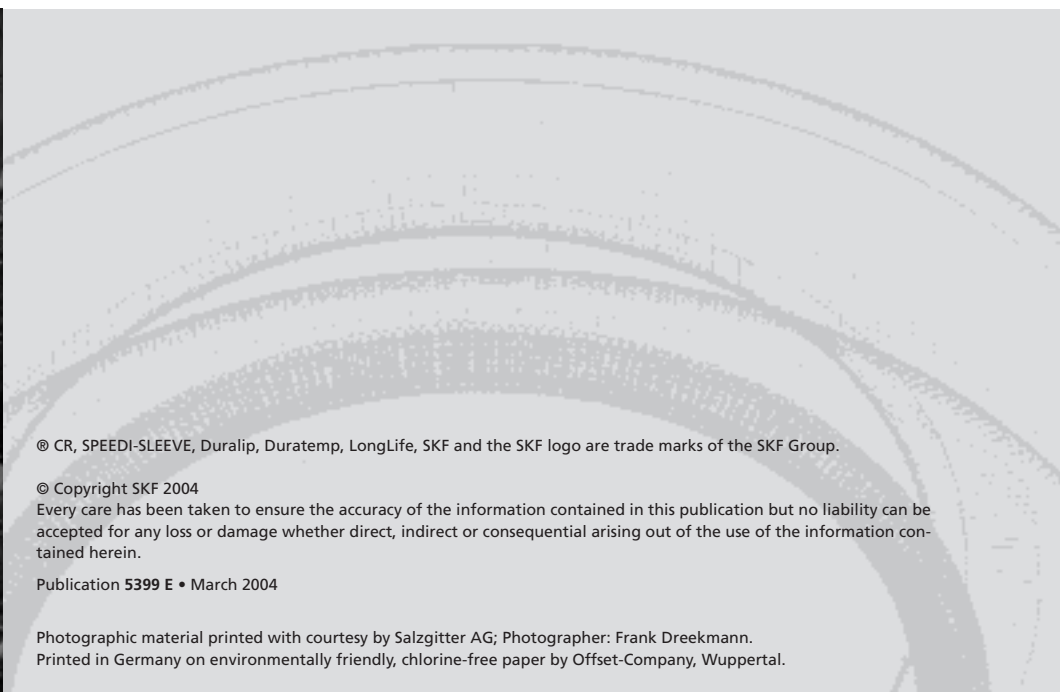

© CR, SPEEDI-SLEEVE, Duralip, Duratemp, LongLife, SKF and the SKF logo are trade marks of the SKF Group.

© Copyright SKF 2004

Every care has been taken to ensure the accuracy of the information contained in this publication but no liability can be accepted for any loss or damage whether direct, indirect or consequential arising out of the use of the information contained herein.

Publication 5399 E • March 2004

Photographic material printed with courtesy by Salzgitter AG; Photographer: Frank Dreekmann.
Printed in Germany on environmentally friendly, chlorine-free paper by Offset-Company, Wuppertal.